

PENTAX DSI-100 SERIES FREQUENCY INVERTER

User's Manual



Introduction

First of all, thank you for choosing DSI-100 series inverter.

DSI-100 series inverter is a general purpose, stable and high performance current vector inverter. Whether VF control or open loop vector control operation, it has reached the industry's leading control level. At the same time, it has random PWM control technology beyond its peers. It can run normally in severe environments such as power grid fluctuation, high temperature, high humidity and concentrated dust, and has extremely high reliability.

Besides excellent performance and reliability, DSI-100 is also more powerful. Simple PLC, built-in PID, multi-stage speed, high-speed pulse, communication and other operation modes can also realize regular operation and switch operation between the two motors. In addition to the standard RS485 interface.

DSI-100 series frequency inverters can be used to drive various kinds of automatic production equipment such as fans, water pumps, textile, paper drawing, machine tools, packaging, food, etc.

Precautions

- ◆ In order to explain the details of the product, the illustrations in this manual sometimes show the state with the cover or safety cover removed. When using this product, please be sure to install the case or cover according to the regulations, and operate according to the contents of the manual.
- ◆ The illustrations in this instruction manual are for illustration only and may differ from the product you ordered.
- ◆ Due to product upgrades or specification changes, and in order to improve the convenience and accuracy of the manual, the contents of this manual will be changed in time.
- ◆ If you need to order the instruction manual due to damage or loss, please contact the regional agents of our company, or contact our customer service center directly.
- ◆ If you still have some problems in use, please contact the customer service center of our company.

Content

Chapter 1: Inspection and Safety Precautions.....	1
1.1. Check after unpacking.....	1
1.1.1. Nameplate Description	1
1.1.2. Model description.....	1
1.3. Precautions.....	4
1.4. Scope of use.....	6
Chapter 2: Standard Specifications.....	7
2.1. Technical Specifications	7
2.2 Standard specification	7
2.3 Sharp and Dimension	10
2.3.1 Product appearance drawing	10
2.3.2 Installation hole size	10
2.3.3 Dimensions keyboard housing	11
Chapter 3: Installation and Circuits Diagram.....	12
3.1 Use environment	12
3.2 Wire diagram.....	12
3.3 Control circuit terminal	13

3.3.1 Control circuit terminal layout	13
3.4. Wiring Precautions	14
Chapter 4: Operating Keyboard.....	16
4.1 Operation keyboard appearance.....	16
4.2 Introduction to Keyboard Indicators	16
Chapter 5: Summary of function parameters	18
Group 00 Monitoring Function Group	18
Group 01 Basic Function Group	19
Group 02 1st Motor Parameters	22
Group 03 The 1st motor vector control parameters	24
Group 04 V/F Control Parameters	25
Group 05 Input Terminals.....	26
Group 06 Output Terminals	29
Group 07 Start/Stop Control.....	31
Group 08 Keyboard and Display	32
Group 09 Auxiliary Functions	34
Group 10 Faults and Protections.....	36
Group 11 PID functions.....	41
Group 12 Swing Frequency, Fixed Length and Count	43
Group 13 Multi-Reference and Simple PLC Function.....	43
Group 14 Communication Parameters	46
Group 17 Function Code Management	46
Group 23 Control Optimization Parameters	47
Chapter 6: Parameter Description	49
Group 00 Monitoring parameter group	49
Group 01 Basic Function Group	52
Group 02 1st Motor Parameters	59
Group 03 Vector Control Parameters	62
Group 04 V/F Control Parameters	64
Group 05 Input Terminals.....	71
Group 06 Output Terminals	79

Group 07 Start/Stop Control	84
Group 08 Keyboard and Display	89
Group 09 Auxiliary Functions	92
Group 10 Faults and Protections.....	100
Group 11 PID functions.....	106
Group 12: Swing Frequency, Fixed Length and Count.....	112
Group13 Multi-stage speed command and simple PLC function	114
Group14 Communication parameters	118
Group 17 User Password.....	118
Group 23 Control optimization parameters	119
Chapter 7 Fault Display and settlement	122
Chapter 8 RS485 Communication Protocol	130

Chapter 1: Inspection and Safety Precautions

The inverters have been strictly tested and quality inspected before leaving the factory. After purchasing, please check whether the packaging of the product is damaged due to careless transportation; whether the specifications and models of the product are consistent with the model ordered. If you have any questions, please contact local dealers, or contact our company directly.

1.1. Check after unpacking

- ※ The inspection includes one machine, one instruction manual, and one warranty card.
- ※ Check the nameplate on the side of the inverter to make sure that the product in your hand is the one you ordered.

1-1-1. Nameplate Description

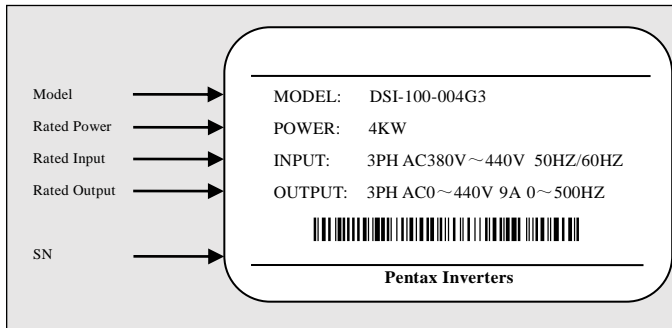
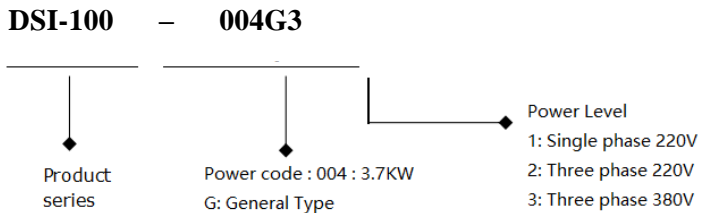

Figure 1-1 Nameplate Description

1-1-2. Model description



1-2. Safety Precautions

In this manual, safety precautions are divided into the following two categories:







Danger: A situation that may result in serious injury or even death due to the danger caused by not operating as required;



CAUTION: Moderate or minor injury, and equipment damage may result due to hazards caused by not operating as required;

Type of Security Matter	Contents of safety precautions
 Danger	<ul style="list-style-type: none"> Do not install it if you find that the control system has entered water, or parts are missing or damaged when unpacking! If the packing list does not match the actual name, please do not install it! It should be handled with care, otherwise there is a danger of damage to the equipment! Please do not use damaged drives or inverters with missing parts. There is a danger of injury! Do not touch the components of the control system with your hands, otherwise there is a danger of static electricity damage!
 Danger	<ul style="list-style-type: none"> Please install it on flame-retardant objects such as metal; keep away from combustibles. Otherwise it may cause a fire! Do not twist the fixing bolts of the equipment components at will, especially the bolts marked with red!
 Caution	<ul style="list-style-type: none"> Do not let the wire head or screw fall into the driver. Otherwise, the drive will be damaged! Please install the driver in a place with less vibration and avoid direct sunlight. When more than two inverters are placed in the same cabinet, please pay attention to the installation position to ensure the heat dissipation effect.
 Danger	<ul style="list-style-type: none"> The instruction of this manual must be followed, and the construction shall be carried out by professional electrical engineering personnel, otherwise there will be unexpected dangers! There must be a circuit breaker between the inverter and the power supply, otherwise a fire may occur! Before wiring, please confirm that the power supply is in a zero-energy state, otherwise there is a danger of electric shock! Please properly ground the inverter according to the standard, otherwise there is danger of electric shock! Never connect the input power to the output terminals (U, V, W) of the inverter. Pay attention to the markings of the terminals, and do not connect the wrong wires! Otherwise, the drive will be damaged! Ensure that the wiring conforms to the EMC requirements and the safety standards of the area where it is located. Please refer to the recommendations in the manual for the wire diameter used. Otherwise an accident may occur! Never connect the braking resistor directly between the DC bus + and - terminals. Otherwise it will cause a fire! Encoder must use shielded wire, and the shielding layer must ensure that the single end is reliably grounded!
 Caution	<ul style="list-style-type: none"> Please confirm whether the voltage level of the input power is consistent with the rated voltage level of the inverter; whether the wiring positions of the power input terminals (R, S, T) and output terminals (U, V, W) are correct; and pay attention to check the connection with the drive. Whether there is a short circuit in the connected peripheral circuits, and whether the connected lines are fastened, otherwise the driver will be damaged! Any part of the inverter does not need to be subjected to the withstand voltage test, the product has been tested before leaving the factory. Otherwise it will cause an accident!

Type of Security Matter	Contents of safety precautions
 Danger	<ul style="list-style-type: none"> ●The inverter can only be powered on after the cover is covered. Otherwise it may cause electric shock! ●The wiring of all peripheral accessories must comply with the instructions of this manual, and make the correct wiring according to the circuit connection method provided in this manual. Otherwise it will cause an accident!
 Danger	<ul style="list-style-type: none"> ●Do not open the cover after power on. Otherwise there is a danger of electric shock! ●Do not touch the driver and peripheral circuits with wet hands. Otherwise there is a danger of electric shock! ●Do not touch any input and output terminals of the inverter. Otherwise there is a danger of electric shock! ●At the beginning of power-on, the inverter automatically performs safety detection on the external strong current circuit. At this time, do not touch the U, V, W terminals of the driver or the motor terminals, otherwise there is a danger of electric shock! ●If parameter identification is required, please pay attention to the danger of injury during motor rotation. Otherwise it may cause an accident! ●Do not arbitrarily change the parameters of the inverter manufacturer. Otherwise, it may cause damage to the equipment!
 Danger	<ul style="list-style-type: none"> ●Do not touch the cooling fan and discharge resistor to test the temperature. Otherwise burns may occur! ●Non-professional technicians should not detect signals during operation. Otherwise it may cause personal injury or equipment damage!
 Caution	<ul style="list-style-type: none"> ●When the inverter is running, it should be avoided that something falls into the equipment. Otherwise, the equipment will be damaged! ●Do not use the method of contactor on and off to control the start and stop of the drive. Otherwise, the equipment will be damaged!
 Danger	<ul style="list-style-type: none"> ●Do not repair and maintain the equipment with electricity. Otherwise there is a danger of electric shock! ●Confirm that the maintenance and repair of the drive can only be carried out when the voltage of the inverter is lower than 36V, which shall be subject to two minutes after the power is cut off. Otherwise, the residual charge on the capacitor will cause harm to people! ●Persons without professional training are not allowed to repair and maintain the inverter. Otherwise, personal injury or equipment damage may be caused! ●After the inverter is replaced, the parameters must be set, and all pluggable plug-ins must be plugged and unplugged in the case of power failure!

1-3. Precautions

Item	note type	Content
1	Motor insulation inspection	Before using the motor for the first time, before using it for a long time, and during regular inspection, the motor insulation should be checked to prevent damage to the inverter due to the insulation failure of the motor winding. During insulation inspection, the motor connection must be separated from the inverter. It is recommended to use a 500V voltage megger, and the measured insulation resistance should be no less than 5MΩ.
2	Thermal protection of the motor	If the selected motor does not match the rated capacity of the inverter, especially when the rated power of the inverter is greater than the rated power of the motor, be sure to adjust the motor protection related parameter values in the inverter or install a thermal Relay in front of the motor to protect the motor.
3	Operation above power frequency	This inverter can provide an output frequency of 0Hz to 500.00Hz. If the customer needs to run above 50Hz, please consider the bearing capacity of the mechanical device.
4	Vibration of mechanical devices	At some output frequencies, the inverter may encounter the mechanical resonance point of the load device, which can be avoided by setting the jump frequency parameter in the inverter.
5	About motor heating and noise	Because the output voltage of the inverter is a PWM wave and contains certain harmonics, the temperature rise, noise and vibration of the motor will increase slightly compared with the power frequency operation.
6	When there is a varistor on the output side or a capacitor to improve power factor	The output of the inverter is PWM wave. If the output side is equipped with a capacitor for improving power factor or a varistor for lightning protection, it is easy to cause instantaneous overcurrent of the inverter or even damage the inverter. Please do not use.
7	Switch devices such as contactors used at the input and output ends of the inverter	If a contactor is installed between the power supply and the input end of the inverter, it is not allowed to use this contactor to control the start and stop of the inverter. When the contactor must be used to control the start and stop of the inverter, the interval should not be less than one hour. Frequent charging and discharging may reduce the service life of the capacitors in the inverter. If there is a switch device such as a contactor between the output end and the motor, make sure that the inverter is switched on and off when there is no output, otherwise the modules in the inverter may be damaged.
8	Use other than rated voltage	It is not suitable to use the DSI-100 series inverter outside the allowable working voltage range specified in the manual, which may cause damage to the components in the inverter. If necessary, use the corresponding boost or step-down device for voltage transformation.
9	Three-phase input is changed to two-phase input	The three-phase inverter in the DSI-100 series cannot be changed to two-phase. Failure to do so will result in malfunction or damage to the inverter.
10	Lightning strike protection	This series of inverters is equipped with lightning strike overcurrent protection device, which has a certain self-protection ability for induced lightning. For places where lightning occurs frequently, customers should also install protection on the front end of the inverter.
11	Altitude and Derating Usage	In areas with an altitude of more than 1000m, the cooling effect of the inverter is deteriorated due to the thin air, so it is necessary to derate the use. In this case, please contact our company for technical consultation.
12	Some special usage	If the customer needs to use methods other than the recommended wiring diagram provided in this manual, such as common DC bus, please consult our company.

Item	note type	Content
13	Pay attention to the scrapping of the inverter	The electrolytic capacitors of the main circuit and the electrolytic capacitors on the printed board may explode when they are burned. Toxic gas will be generated when the plastic parts are burned. Please dispose of them as industrial waste.
14	About the Adapter Motor	<p>1) The standard matching motor is a four-pole squirrel-cage asynchronous induction motor. If it is not the above motor, please select the inverter according to the rated current of the motor.</p> <p>2) The cooling fan of the non-variable frequency motor is coaxially connected to the rotor shaft, and the cooling effect of the fan decreases when the speed decreases. Therefore, if the motor is overheated, a strong exhaust fan should be installed or replaced with a frequency conversion motor;</p> <p>3) The frequency converter has built-in standard parameters of the adapted motor. According to the actual situation, it is necessary to identify the motor parameters or modify the default values to match the actual values as much as possible, otherwise the operation effect and protection performance will be affected;</p> <p>4) Due to the short circuit in the cable or the motor, the inverter will alarm, or even the machine will be fried. Therefore, please first perform an insulation short-circuit test on the initially installed motor and cable, and this test should also be performed frequently during routine maintenance. Note that the inverter must be completely disconnected from the tested part when doing this test.</p>
15	other	<p>1) Never connect the AC power supply to the U, V, W and other terminals of the inverter output.</p> <p>2) The panel must be fixed and locked before power-on, so as to avoid personal safety damage due to defective internal capacitors and other components.</p> <p>3) After the power is turned on, wiring, inspection, etc. cannot be performed.</p> <p>4) After the device is powered on, do not touch the internal circuit board and its components to avoid the danger of electric shock.</p> <p>5) Turn off the power, and within 5 minutes after the keyboard display goes out, do not touch the circuit board and any parts in the machine, and you must use the instrument to confirm that the capacitors in the machine have been discharged before performing the operation in the machine, otherwise there will be electric shock. Danger.</p> <p>6) The static electricity of the human body will seriously damage the internal MOS field effect transistors, etc. If anti-static measures are not taken, do not touch the internal devices such as printed circuit boards and IGBTs with your hands, otherwise it may cause malfunctions.</p> <p>7) When using, the grounding terminal (E or \perp) of the inverter should be properly and reliably grounded according to the national electrical safety regulations and other relevant standards. Do not stop the machine by pulling the brake (power off), and cut off the power supply after the motor stops running.</p> <p>8) The optional input filter accessories must be added to meet the CE standard.</p>

1-4. Scope of use

- ※ This inverter is only suitable for general industrial three-phase AC asynchronous motors.
- ※ This inverter can only be used in the occasions approved by our company. Unapproved use environment may cause fire, electric shock, explosion and other events.
- ※ If it is used in equipment that may cause personal injury or death due to inverter failure (for example: lifting equipment for transporting personnel, aviation systems, safety equipment, etc.), it must be handled with care. In this case, please consult the manufacturer.

Use environment

- (1) Ambient temperature -10°C~40°C.
- (2) Prevent electromagnetic interference and stay away from interference sources.
- (3) Prevent the intrusion of water droplets, steam, dust, cotton wool and fine metal powder.
- (4) Prevent the intrusion of oil, salt and corrosive gas.
- (5) Avoid vibration.
- (6) Avoid high temperature and humidity and no rain dripping, and the humidity is less than 90%RH (no condensation).
- (7) It is forbidden to use it in the dangerous environment of flammable, combustible, explosive gas, liquid or solid.

Only trained personnel are allowed to operate this device, please read the safety, installation, operation and maintenance sections of this manual carefully before use.

The safe operation of this equipment depends on proper transport, installation, operation and maintenance!

Chapter 2: Standard Specifications

2-1. Technical Specifications

Model	Input voltage	Output power (KW)	Input current (A)	Output current (A)	Match motor KW
DSI-100-K75G1	Single-phase AC220V±15 50/60Hz	0.75	8.2	4.0	0.75
DSI-100-1K5G1		1.5	14.0	7.0	1.5
DSI-100-2K2G1		2.2	23.0	9.6	2.2
DSI-100-K75G3	Three-phase AC380V~440V -15%~+10% 50/60Hz	0.75	3.4	2.3	0.75
DSI-100-1K5G3		1.5	5.0	3.7	1.5
DSI-100-2K2G3		2.2	5.8	5.0	2.2
DSI-100-004G3		3.7	10.5	9.0	3.7
DSI-100-5K5G3		5.5	14.6	13	5.5

2-2 Standard specification

Item		Specification
Basic function	Highest frequency	Vector control: 0~500Hz; V/F control: 0~500Hz
	Carrier frequency	0.8kHz-12kHz the carrier frequency can be adjusted automatically according to the load characteristics.
	Input frequency resolution	Digital setting: 0.01HZ Analog setting: Maximum frequency × 0.025%
	Control mode	Open loop vector control (SVC) and V/F control
	Start torque	0.5Hz/150% (SVC)
	Speed range	1: 100 (SVC)
	Speed control accuracy	±0.5% (SVC)
	Overload capacity	150% rated current 60sec; 180% rated current 3sec
	Torque boost	Auto-torque boost; manual torque boost 0.1%~30.0%
	V/F curve	Three types: linear type; Multi-point type; the nth power of V/F curve
	ACC/DEC curve	Linear or S curve of ACC/DEC ways. Four types of ACC/DEC Time, ACC/DEC time range is 0.0~6500.0s
	DC brake	DC brake frequency: 0.00Hz~ max frequency, brake time: 0.0s~36.0s,brake action current: 0.0%~100.0%
	JOG Control	JOG frequency range: 0.00Hz~50.00Hz. JOG speed-up/down time: 0.0s~6500.0.s
Simple PLC, multi-stage speed	Via built-in PLC or control terminal can realize max 16 stage speed running	

Item		Specification
	running	
	Built-in PID	Can realize process control close-loop system conveniently
	Auto-adjust voltage (AVR)	When grid voltage changes, can keep output voltage steadily automatically
	Over current and over	During running, limit current and voltage automatically, protect from tripping off frequently for over voltage and over current.
	Quick current-limit function	Reduce over current error on max extent, protect inverter normal running
	Torque limitation and control	“digger” feature, inverter could limit torque automatically, prevent over current tripping off;
Personable function	Outstanding perform	Using high-perform current vector control
	Instance stop not stop	During instant power-off, by motor feedback energy, inverter compensates voltage-drop to keep running for short time.
	Quick current-limit function	Reduce over current error on max extent
	Timing control	timing control function: setting time range: 0.0min~6500.0min
	Command source	control panel, control terminal, communication; can be switched by several modes
	Frequency source	digital setting, analog voltage setting, analog current setting, pulse setting, communication setting, can be switched by several methods
Running	Input terminal	Standard: 5 digital input terminal, one of them support max 100KHz HS pulse input; 2 analog input terminal, AI1 support 0~10V voltage input, AI2 support 0~10V voltage or 0~20mA current

Item		Specification
	Output terminal	Standard: 1 high-speed pulse output terminal(optional open collector),support 0~100kHz pulse 1 Relay output terminal 1 analog output support 0~10V voltage or 0~20mA current
Display and keypad	LED display	Can display parameter
	Press-key locking and function selection	Realize press-key partial or full locking, define part press-key function range, to avoid wrong operation
	Protection function	Power-on motor short circuit test, output phase-loss protection, over-current protection, over-voltage protection, under-voltage protection, overheat protection, overload protection etc.
Environment	Application site	Indoor, without direct sunlight, no powder, corrosive gas, combustion air, oil dust, water steam, water drop or salt etc.
	Altitude level	Less than 1000m, Derating below 1000m, the rated output current is reduced by 1% for every 100m increase
	Environment temperature	-10°C~+40°C (During 40°C~50°C, please reduce capacity use)
	Humidity	<95% RH, no water drop condensed

2-3. Sharp and Dimension

2-3-1. Product appearance drawing

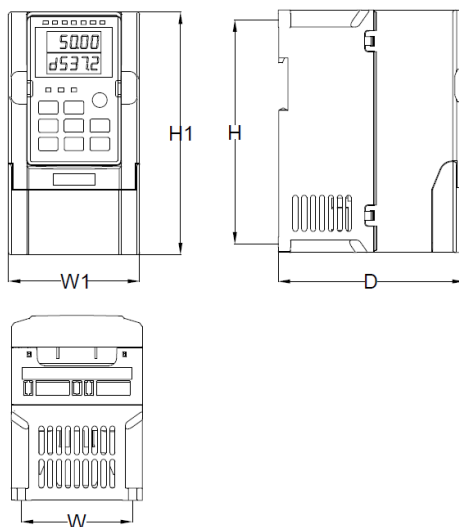

Figure 2-1 Product outline drawing and installation hole size

2-3-2. Installation hole size

Model	Outline Dimension (mm)						
	W	H	D	W1	H1	Mounting hole(d)	weight
DSI-100-K75G1	75	151.5	125.5	88.5	164	5	0.9
DSI-100-1K5G1							
DSI-100-2K2G1							
DSI-100-K75G3							
DSI-100-1K5G3							
DSI-100-2K2G3							
DSI-100-004G3	86	170.5	136.5	97	184	5	1.3
DSI-100-5K5G3							

Figure 2-2 Product dimension and installation

2-3-3. Dimensions keyboard housing

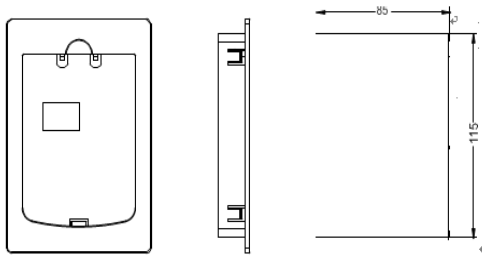

Chapter 3: Installation and Circuits Diagram

3-1. Use environment

- (1) Ambient temperature $-10^{\circ}\text{C}\sim 40^{\circ}\text{C}$.
- (2) Prevent electromagnetic interference and stay away from interference sources.
- (3) Prevent the intrusion of water droplets, steam, dust, dust, cotton wool and fine metal powder.
- (4) Prevent the intrusion of oil, salt and corrosive gas.
- (5) Avoid vibration.
- (6) Avoid high temperature and humidity and no rain dripping, and the humidity is less than 90%RH (no condensation).
- (7) It is forbidden to use it in the dangerous environment of flammable, combustible, explosive gas, liquid or solid.

3-2 Wire diagram

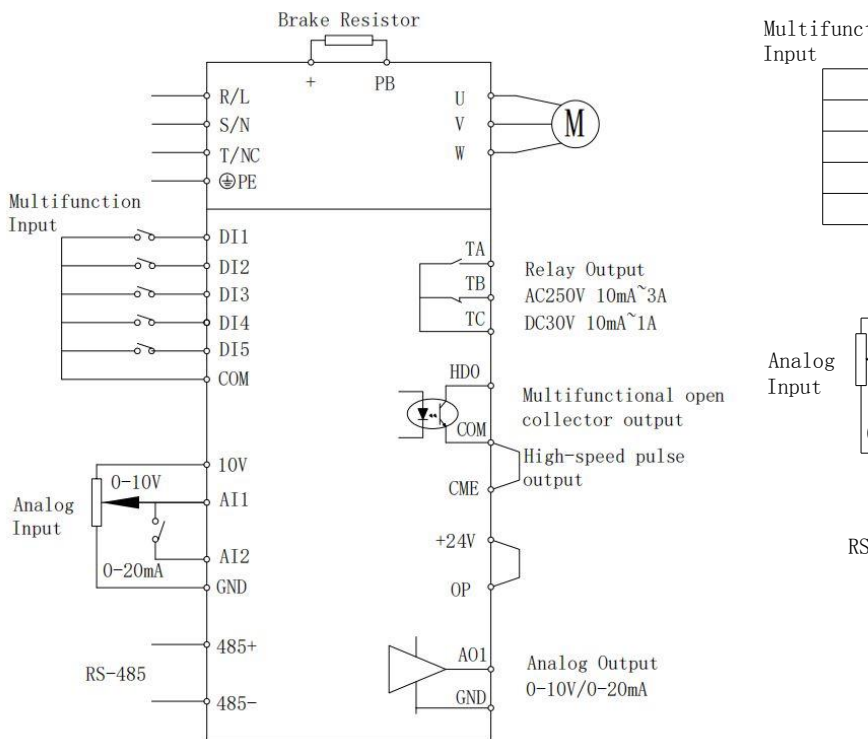
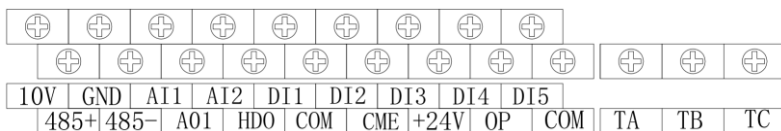

Figure 3-1 Wiring diagram

The inverter wiring is divided into two parts: the main circuit and the control circuit. The user must make the correct connection according to the wiring circuit shown in the figure above.

3-3. Control circuit terminal

3-3-1 Control circuit terminal layout



3-3-2. Control circuit terminal description

Terminal	Description	Function
HDO-CME	OC type DO	Optocoupler isolation, bipolar open collector output. Output voltage range: 0-24V. Output current range: 0-50mA.
HDO-COM	High-speed pulse output	When used as high-speed pulse output, the maximum frequency is 100KHz. Disconnect the COM and CME shorting jumper
TA/TB/TC	Relay output	Contact drive capability: AC250V, 3A, COSΦ=0.4DC30V, 1A TC→TA is NO, TC→TB is NC
10V-GND	+10V power supply	Provide 10V power supply to the outside, the maximum output current: 10mA Generally used as an external potentiometer power supply, the potentiometer resistance range is 1KΩ-5KΩ
+24V-COM	+24V power supply	Provide +24V power supply to the outside, generally used as the working power supply of digital input and output terminals and external sensors The maximum output current of the power supply: 200mA
OP	External power input	The factory default is connected with 24V, When using external signals to drive DI1~DI5, the OP needs to be connected to the external power supply and disconnected from the +24V power supply terminal
DI1-OP	DI1	1. Optocoupler isolation, compatible with bipolar input 2. Input impedance: 2.4kΩ 3. Voltage range for level input: 9V~30V
DI2-OP	DI2	
DI3-OP	DI3	
DI4-OP	DI4	
DI5-OP	High-speed pulse input terminal	In addition to the characteristics of DI1~DI4, It can also be used as a high-speed pulse input channel. Maximum input frequency: 100kHz
AI1	Multi-function analog input signal 1	1. Adjustable in the range of 0-10V. 2. The input impedance is 22kΩ, and the current input is 500Ω.
AI2	Multi-function analog input signal 2	1. JP2 1-2 short circuit: adjustable within the range of 0-10V. 2. JP2 2-3 short circuit: adjustable within the range of 0-20mA. 3. The input impedance is 22kΩ, and the current input is 500Ω.

AO1	Multi-function analog output	1. JP1 1-2 short circuit: adjustable within the range of 0-10V. 2. JP2 2-3 short circuit: adjustable within the range of 0-20mA.
485+ 485-	RS-485	Standard RS485 communication interface, not isolated from GND, please use twisted pair or shielded wire

3-4. Wiring Precautions

※It is not allowed to install phase-advancing capacitors or resistance-capacitance absorption devices at the U, V, W output ends of the inverter. When replacing the motor, the input power of the inverter must be cut off.

※Do not drop metal scraps or wire ends into the inverter when wiring, otherwise the inverter may malfunction.

※The motor can be switched or the industrial frequency power supply can be switched only when the inverter stops outputting.

※In order to minimize the influence of electromagnetic interference, when the electromagnetic contactor and Relay used are close to the inverter, it is necessary to consider installing a surge absorbing device.

※The external control line of the inverter must be equipped with an isolation device or a shielded line.

※In addition to shielding, the input command signal wiring should also be routed separately, preferably away from the main circuit wiring.

※When the carrier frequency is less than 3KHz, the maximum distance between the inverter and the motor should be within 50 meters; when the carrier frequency is greater than 4KHz, the distance should be appropriately reduced, and the wiring should be laid in a metal pipe.

※When the inverter is equipped with peripheral equipment (filters, reactors, etc.), first measure its insulation resistance to ground with a 1000-volt megohmmeter to ensure that it is not less than 4 megohms.

※When the inverter needs to be started frequently, do not turn off the power supply, and must use the control terminal or keyboard or RS485 running command to start and stop to avoid damage to the rectifier.

※Do not connect the AC input power supply to the output terminals U, V and W of the inverter.

※In order to prevent accidents, the ground terminal () must be grounded reliably (the ground impedance should be below 100 ohms), otherwise there will be leakage.

※When the main circuit is wired, the selection of the wire diameter specification should be carried out in accordance with the relevant provisions of the national electrical regulations.

※The motor capacity should be equal to or smaller than the inverter capacity.

Chapter 4: Operating Keyboard

4-1. Operation keyboard appearance

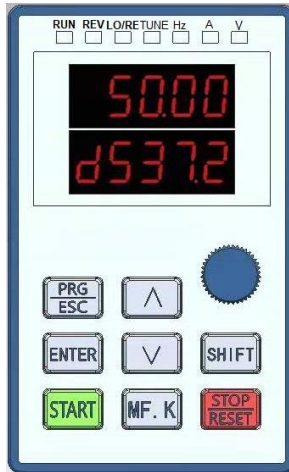

4-2. Introduction to Keyboard Indicators

Indicator		Indicator function	Indicator status
Unit indicator	Hz	Frequency	Always on: The current displayed number is the frequency
	A	Current	Always on: The current displayed number is the current
	V	Voltage	Always on: The current displayed number is the voltage
	Hz+A	Speed	Both two lights are always on: the current display number is the speed
	A+V	Percentage	Steady on: The current displayed number is the percentage
Status indicator	RUN	Operating status	Always on: the inverter is running Always off: the inverter is in stop state
	LOCAL	Run command mode	Always on: Terminal control mode Blinking: Communication control mode Always off: Operation panel control mode
	FWD/REV	Forward/Reverse	Always on: the inverter is in the reverse state Always off: the inverter is in the forward rotation state
	TUNE	Tuning, Torque Control, Fault Indicator	Steady on: the inverter is in torque control mode Blinking slowly: the inverter is in tuning state Flashing quickly: the inverter is in fault state

A total of 5-digit LED display can display various monitoring data such as set frequency, output frequency, output current, output voltage, and alarm codes.

4-3. Operation panel key description

Key	Name	Function
PRG	Program	Level 1 menu entry or exit
ENTER	Confirm	Enter the menu interface level by level, set parameters to confirm
⤴	Increment	Increment of data or function code
⤵	Decrement	Decrement of data or function code
SHIFT	Shift	In the stop display interface and the running display interface, the display parameters can be selected cyclically; when modifying the parameters, the modification bits of the parameters can be selected
RUN	RUN	In keyboard operation mode, used to run operation
MF.K	Multi-function selection	According to 08-01 for function switch selection, it can be defined as command source, or direction quick switch
STOP/RESET	Stop/Reset	In the running state, pressing this key can be used to stop the running operation; in the fault alarm state, it can be used to reset the operation. The characteristics of this key are restricted by the function code 08-02.

Chapter 5: Summary of function parameters

The parameter menu in the user-defined parameter mode is not password protected. Group 0 is the basic function parameters, monitoring function parameters.

The symbols in the function table are explained as follows:

"◇": Indicates that the set value of this parameter can be changed when the inverter is in stop or running state;

"□": Indicates that the set value of this parameter cannot be changed when the inverter is running;

"■": Indicates that the value of this parameter is the actual detection record value and cannot be changed;

"*": Indicates that the parameter is a "manufacturer parameter", which is limited to the manufacturers Settings, and the user is prohibited from operating

Group 00 Monitoring Function Group

Para. No.	Para. Name	Display Range	Modify	COM Add.
00.00	Running frequency	0-500.00Hz	■	7000
00.01	Frequency reference	0-500.00Hz	■	7001
00.02	Bus voltage	0-3000V	■	7002
00.03	Output voltage	0-1140V	■	7003
00.04	Output current	0-655.35A	■	7004
00.05	Output power	0-32767KW	■	7005
00.06	Output torque	-200.0%-200.0%	■	7006
00.07	DI state	0-32767	■	7007
00.08	DO state	0-1023	■	7008
00.09	AI1 voltage	0-10.57V/0-20.000m	■	7009
00.10	AI2 voltage/current	0-10.57V/0-20.000m	■	700A
00.12	Count value	0-65535	■	700C
00.13	length value	0-65535	■	700D
00.14	Load speed display	0-65535	■	700E
00.15	PID reference	0-100.0Bar	■	700F
00.16	PID feedback	0-100.0Bar	■	7010
00.17	PLC stage	0-16	■	7011
00.18	Pulse reference	0-100.00KHz	■	7012
00.19	feedback speed	-500.00Hz-500.00Hz	■	7013
00.20	Remaining running time	0-65535Min	■	7014
00.21	AI1 voltage before correction	0-10.57V/0-20.000mA	■	7015
00.22	AI2 voltage (V)/ current (MA) before correction	0-10.57V/0-20.000mA	■	7016

Para. No.	Para. Name	Display Range	Modify	COM Add.
00.24	Motor speed	0-65535m/Min	■	7018
00.25	Accumulative power-on time	0-65535Min	■	7019
00.26	Accumulative running time	0-65535Min	■	701A
00.27	Pulse reference	0-65535Hz	■	701B
00.28	Communication reference	-100.0%-100.0%	■	701C
00.30	Main frequency A reference	0-500.00Hz	■	701E
00.31	Auxiliary frequency B reference	0-500.00Hz	■	701F
00.32	Viewing any register address value	-	■	7020
00.35	Motor temperature	-200.0%-200.0%	■	7023
00.37	Target torque	-	■	7025
00.39	Target voltage upon V/F separation	0-Motor rated voltage	■	7027
00.40	Output voltage upon V/F separation	0-Motor rated voltage	■	7028
00.41	S state display	-	■	7029
00.42	HDO state display	-	■	702A
00.43	S set for function state display 1	-	■	702B
00.44	S set for function state display 2	-	■	702C
00.45	fault information	-	■	702D
00.59	Frequency Reference	-100.00%-100.00%	■	703B
00.60	Running frequency	-100.00%-100.00%	■	703C
00.61	AC drive state	0-65535	■	703D
00.62	Current fault code	0-99	■	703E

Group 01 Basic Function Group

Para. No.	Para. Name	Setting Range	Default	Modify	COM Add.
01.01	Motor 1 control mode	0: Sensor-less vector control (SVC) 1: Reserved 2: V/F control	2	□	F001
01.02	Command source selection	0: Operation panel 1: Terminal 2: Communication	0	◇	F002

Para. No.	Para. Name	Setting Range	Default	Modify	COM Add.
01.03	Main frequency reference setting X channel selection	0:digital setting (preset frequency 01.08, UP / DOWN can be modified, power is not memory) 1:digital setting (preset frequency 01.08, UP / DOWN can be modified, power-down memory) 2: AI1 3: AI2 4: AI3(Keyboard potentiometer) 5:High-speed pulse input setting (DI5) 6: Multi-segment instructions 7: Simple PLC 8: PID 9: communication given 10: Reserved	4	<input type="checkbox"/>	F003
01.04	Auxiliary frequency source Y command input selection	Same as 01.03 (main frequency source A instruction input selection)	0	<input type="checkbox"/>	F004
01.05	Auxiliary frequency source Y Reference object selection	0: relative to maximum frequency 1: Relative to frequency source X	0	<input type="checkbox"/>	F005
01.06	Auxiliary frequency source Y command range	0% ~ 150%	100%	<input type="checkbox"/>	F006
01.07	Frequency source combination mode selection	Bit: frequency source selection 0: Main frequency source X 1: main and auxiliary operation results (operation relationship determined by ten) 2: Main frequency source X and auxiliary frequency source Y switch 3: Main frequency source X and master and slave operation result switching 4: auxiliary frequency source Y and master and slave operation result switching Ten: frequency source main and auxiliary operation relationship 0: main + auxiliary 1: main - auxiliary 2: the two maximum 3: the two minimum	00	<input type="checkbox"/>	F007
01.08	Preset frequency	0.00Hz~max frequency (01.10)	50.00Hz	<input type="checkbox"/>	F008

Para. No.	Para. Name	Setting Range	Default	Modify	COM Add.
01.09	Running direction	0:Same direction 1:Opposite direction	0	◇	F009
01.10	Max. frequency	50.00Hz~500.00Hz	50.00Hz	□	F00A
01.11	Setting channel of frequency upper limit	0: 01.12 is set 1: AI1 2: AI2 3:AI3 (Keyboard potentiometer) 4:High-speed pulse setting (DI5) 5: Communication given	0	□	F00B
01.12	Frequency reference upper limit	Lower limit 01.14~max frequency 01.10	50.00Hz	◇	F00C
01.13	Frequency reference upper limit offset	0.00Hz~max frequency 01.10	0.00Hz	◇	F00D
01.14	Frequency reference lower limit	0.00Hz to frequency upper limit 01.12	0.00Hz	◇	F00E
01.15	Carrier frequency	0.8kHz~12.0kHz	Model determined	◇	F00F
01.16	Carrier frequency adjusted with temperature	0: No 1: Yes	1	◇	F010
01.17	Acceleration time 1	0.00s~65000s *01.19	Model determined	◇	F011
01.18	Deceleration time 1	0.00s~65000s *01.19	Model determined	◇	F012
01.19	Acceleration /Deceleration time unit	0: 1s 1: 0.1s 2: 0.01s	1	□	F013
01.20	Power-on automatic running delay time setting	0.0s~3600.0s	Model determined	◇	F014
01.21	Frequency offset of Auxiliary frequency setting channel for main and auxiliary calculation	0.00Hz~max frequency 01.10	0.00Hz	◇	F015
01.22	Frequency reference	1: 0.1Hz 2: 0.01Hz	2	□	F016

Para. No.	Para. Name	Setting Range	Default	Modify	COM Add.
	resolution				
01.23	Retentive of digital setting frequency upon stop	0: No memory 1: Memory	1	◇	F017
01.24	Motor parameter group selection	0: 1st motor parameter 1: Reserved	0	□	F018
01.25	Acceleration /Deceleration time base frequency	0: Maximum frequency (01.10) 1: Set frequency 2: 100Hz	0	□	F019
01.26	Base frequency for UP/DOW modification during running	0: Run frequency 1: Set frequency	1	□	F01A
01.27	The run command is tied to the main frequency source X command selection:	Bit: Operation panel command Bind frequency source selection 0: no binding 1: Digital setting frequency 2: AI1 3: AI2 4: AI3 (Keyboard potentiometer) 5: High-speed pulse input setting (DI5) 6: multi-speed 7: Simple PLC 8: PID 9: communication given Ten: Terminal Command Binding Frequency Source Selection Hundreds: communication command binding frequency source selection	0000	◇	F01B

Group 02 1st Motor Parameters

Para. No.	Para. Name	Setting Range	Default	Modify	COM Add.
02.00	Motor type selection	0: Ordinary asynchronous motor 1: Variable frequency asynchronous motor 2: Reserved	0	□	F100
02.01	Rated motor power	0.1KW~1000.0KW	Model determined	□	F101
02.02	Rated motor voltage	1V~2000V	Model determined	□	F102

Para. No.	Para. Name	Setting Range	Default	Modify	COM Add.
02.03	Rated motor current	0.01A~655.35A (Inverter power<=55KW) 0.1A~6553.5A (Inverter power>55KW)	Model determined	<input type="checkbox"/>	F103
02.04	Rated motor frequency	0.01Hz~Max frequency	Model determined	<input type="checkbox"/>	F104
02.05	Rated motor speed	1rpm~65535rpm	Model determined	<input type="checkbox"/>	F105
02.06	Stator resistance	0.001Ω~65.535Ω (Inverter power<=55KW) 0.0001Ω~6.5535Ω (Inverter power>55KW)	Auto-tuning dependent	<input type="checkbox"/>	F106
02.07	Rotor resistance	0.001Ω~65.535Ω (Inverter power<=55KW) 0.0001Ω~6.5535Ω (Inverter power>55KW)	Auto-tuning dependent	<input type="checkbox"/>	F107
02.08	Leakage inductive reactance	0.01mH~655.35mH (Inverter power<=55KW) 0.001mH~65.535mH (Inverter power>55KW)	Auto-tuning dependent	<input type="checkbox"/>	F108
02.09	Mutual inductive	0.1mH~6553.5mH (Inverter power<=55KW) 0.01mH~655.35mH (Inverter power>55KW)	Auto-tuning dependent	<input type="checkbox"/>	F109
02.10	No-load current	0.01A~02.03 (Inverter power<=55KW) 0.1A~02.03 (Inverter power>55KW)	Auto-tuning dependent	<input type="checkbox"/>	F10A
02.37	Motor auto-tuning method selection	0: no operation 1:Asynchronous machine static part of the parameters of self-learning 2:asynchronous machine dynamic complete self-learning 3:asynchronous machine static complete self-learning	0	<input type="checkbox"/>	F125

Group 03 the motor vector control parameters

Para. No.	Para. Name	Setting Range	Default	Modify	COM Add.
03.00	Speed loop proportional gain1	1~100	30	◇	F200
03.01	Speed loop integral time 1	0.01s~10.00s	0.50s	◇	F201
03.02	Switch over frequency 1	0.00~03.05	5.00Hz	◇	F202
03.03	Speed loop proportional gain 2	1~100	20	◇	F203
03.04	Speed loop integral time 2	0.01s~10.00s	1.00s	◇	F204
03.05	Switch over frequency 2	03.02~Max frequency(01.10)	10.00Hz	◇	F205
03.06	SVC slip compensation gain	50%~200%	100%	◇	F206
03.07	SVC Speed feedback filter time constant	0.000s~0.100s	0.015s	◇	F207
03.08	Torque limit source in speed control	0~200	64	◇	F208
03.09	Digital setting of torque limit in speed control	0: Function code 03.10 setting 1: AI1 2: AI2 3: AI3(keyboard potentiometer) 4: High-speed pulse input setting (DI5) 5: Communication given 6: MIN (AI1, AI2) 7: MAX (AI1, AI2) 1-7 option full scale corresponds to 03.10	0	◇	F209
03.10	Speed loop proportional gain1	0.0%~200.0%	150.0%	◇	F20A
03.13	Excitation adjustment proportional gain	0~60000	2000	◇	F20D
03.14	Excitation adjustment integral gain	0~60000	1300	◇	F20E
03.15	Torque adjustment proportional gain	0~60000	2000	◇	F20F
03.16	Torque adjustment integral gain	0~60000	1300	◇	F210

Group 04 V/F Control Parameters

Para. No.	Para. Name	Setting Range	Default	Modify	COM Add.
04.00	V/F curve setting	0: Straight line V / F 1: Multi-point V / F 2: Square V / F 3: 1.2 Power V / F 4: 1.4 Power V / F 6: 1.6 Power V / F 8: 1.8 power V / F 9: Reserved 10: VF complete separation mode 11: VF semi-separation mode	0	□	F300
04.01	Torque boost	0.0%: (Ineffective) 0.1%~30.0%	0.0%	◇	F301
04.02	Cut-off frequency of torque boost	0.00Hz~max frequency	50.00Hz	□	F302
04.03	Multi-point V/F frequency 1	0.00Hz~04.05	0.00Hz	□	F303
04.04	Multi-point V/F voltage 1	0.0%~100.0%	0.0%	□	F304
04.05	Multi-point V/F frequency 2	04.03~04.07	0.00Hz	□	F305
04.06	Multi-point V/F voltage 2	0.0%~100.0%	0.0%	□	F306
04.07	Multi-point V/F frequency 3	04.05~motor rated frequency (02.04)	0.00Hz	□	F307
04.08	Multi-point V/F voltage 3	0.0%~100.0%	0.0%	□	F308
04.09	V/F Slip compensation gain	-	100.0%	◇	F309
04.10	V/F over-excitation gain	0~200	64	◇	F30A
04.11	V/F oscillation suppression gain	0~100	Model determined	◇	F30B
04.13	Voltage source for V/F separation	0: digital setting (04.14) 1: AI1 (Note: J6 jumper) 2: AI2 3: AI3(keyboard potentiometer) 4: High-speed pulse input setting (DI5) 5: Multi-segment instructions 6: Simple PLC 7: PID 8: Communication given Note: 100.0% corresponds to the motor rated voltage	0	◇	F30D
04.14	Digital setting of	0V~motor rated voltage	0V	◇	F30E

Para. No.	Para. Name	Setting Range	Default	Modify	COM Add.
	voltage for V/F separation				
04.15	Voltage rise time of V/F separation	0.0s~1000.0s Note: 0V to rated motor voltage	0.0s	◇	F30F
04.16	Voltage decline time of V/F separation	0.0s~1000.0s Note: time of 0v to rated motor voltage	0.0s	◇	F310
04.17	Stop mode selection for V/F separation	0: Frequency/voltage is reduced to 0 independently 1: The frequency starts to drop after the voltage is reduced to 0	0	◇	F311
04.19	Current limit selection	0: Useless 1: Useful	1	◇	F313
04.20	Current limit gain	0~100	20	◇	F314
04.21	Compensation factor of speed multiplying current limit level	50~200%	50%	◇	F315
04.22	Voltage limit	650V~800.0V	220V : 380V 380: 760V	◇	F316
04.23	Voltage limit selection	0: Useless 1: Useful	1	◇	F317
04.24	Frequency gain for voltage limit	0~100	30	◇	F318
04.25	Voltage gain for voltage limit	0~100	30	◇	F319
04.26	Frequency rise threshold during voltage limit	0~50Hz	5Hz	◇	F31A
04.27	Slip Compensation Time Constant	0.1-10.0s	0.5s	◇	F31B

Group 05 Input Terminals

Para. No.	Para. Name	Setting Range	Default	Modify	COM Add.
05.00	DI1 function selection	0: No function 1: Forward RUN (FWD) 2: Reverse RUN (REV) 3: Three-line control 4: Forward JOG (FJOG) 5: Reverse JOG (RJOG) 6: Terminal UP 7: Terminal DOWN	1	□	F400
05.01	DI2 functions election		2	□	F401
05.02	DI3 functions election		8	□	F402
05.03	DI4 functions election		9	□	F403
05.04	DI5 functions election		12	□	F404

Para. No.	Para. Name	Setting Range	Default	Modify	COM Add.
05.05	Reserved	8: Coast to stop	13	<input type="checkbox"/>	F405
05.06	Reserved	9: Fault reset (RESET) 10: RUN pause	0	<input type="checkbox"/>	F406
05.07	Reserved	11: Normally open input of external fault 12: Multi-reference terminal 1	0	<input type="checkbox"/>	F407
05.08	Reserved	13: Multi-reference terminal 2 14: Multi-reference terminal 3 15: Multi-reference terminal 4 16: Terminal 1 for acceleration/ deceleration time selection 17: Terminal 2 for ACC/DEC time selection 18: Frequency source switchover 19: UP and DOWN setting clear (terminal, operation panel) 20: Command source switchover terminal 1 21: Acceleration/Deceleration prohibited 22: PID pause 23: PLC status reset 24: Swing pause 25: Counter input 26: Counter reset 27: Length count input 28: Length reset 29: Reserved 30: Pulse input (enabled only for DI5) 31:Reserved	0	<input type="checkbox"/>	F408
05.09	Reserved	32: Immediate DC braking 33: Normally closed input of external fault 34: Frequency modification forbidden 35: Reverse PID action direction 36: External STOP terminal 1 37: Command source switchover terminal 2 38: PID integral pause 39: Switchover between main frequency source X and preset frequency 40: Switchover between auxiliary frequency source Y and preset frequency 41: Reserved 42: Reserved 43: PID parameter switchover 44: User-defined fault 1 45: User-defined fault 2 46: Reserved 47: Emergency stop 48: External STOP terminal 2 49: Deceleration DC braking 50: Clear the current running time 51: Run terminal below the forced under voltage point 52: Deceleration stop function, JOG is valid 53-59: Reserved	—	<input type="checkbox"/>	F409
05.10	DI filter time	0.000– 1.000s	0.010s	<input type="checkbox"/>	F40A

Para. No.	Para. Name	Setting Range	Default	Modify	COM Add.
05.11	Terminal command mode	0: Two-line mode 1 1: Two-line mode 2 2: Three-line mode 1 3: Three-line mode 2	0	<input type="checkbox"/>	F40B
05.12	Terminal UP/DOWN rate	0.01~65.535 Hz/s	1.00Hz/s	◇	F40C
05.13	AI curve 1 minimum input	0.00V to 05.15	0.00V	◇	F40D
05.14	Corresponding setting of AI curve 1 minimum input	-100.0% ~+100.0%	0.0%	◇	F40E
05.15	AI curve 1 maximum input	05.13~+10.00V	10.00V	◇	F40F
05.16	Corresponding setting of AI curve 1	-100.0% ~+100.0%	100.0%	◇	F410
05.17	AI1 filter time	0.00s~10.00s	0.10s	◇	F411
05.18	AI curve 2 minimum input	0.00V~05.20	0.00V	◇	F412
05.19	Corresponding setting of AI curve 2 minimum input	-100.0% ~+100.0%	0.0%	◇	F413
05.20	AI curve 2 maximum input	05.18~+10.00V	10.00V	◇	F414
05.21	Corresponding setting of AI curve 2 maximum input	-100.0% ~+100.0%	100.0%	◇	F415
05.22	AI2 filter time	0.00s~10.00s	0.10s	◇	F416
05.28	Pulse minimum input	0.00kHz~05.30	0.00KHz	◇	F41C
05.29	Corresponding setting of pulse minimum input	-100.0% ~100.0%	0.0%	◇	F41D
05.30	Pulse maximum input	05.28~100.00KHz	50.00KHz	◇	F41E
05.31	Corresponding setting of pulse maximum input	-100.0% ~100.0%	100.0%	◇	F41F
05.32	Pulse filter time	0.00s~10.00s	0.10s	◇	F420

Para. No.	Para. Name	Setting Range	Default	Modify	COM Add.
05.33	AI curve selection	Bit: AI1 curve selection 1: curve 1 (2 points, see 05.13 ~ 05.16) 2: Curve 2 (2 points, see 05.18 ~ 05.21) 3: curve 3 (2 points, see 05.23 ~ 05.26) 4: curve 4 (4 points, see 24.00 ~ 24.07) 5: curve 5 (4 points, see 24.08 ~ 24.15) Ten: AI2 curve selection, as above Hundreds: Reserved	321	◇	F421
05.34	Setting selection when AI less than min. input	Bit: AI1 is lower than the minimum input setting 0: corresponds to the minimum input setting 1: 0.0% Ten: AI2 is lower than the minimum input setting, as above Hundreds: Reserved	000	◇	F422
05.35	DI1 delay time	0.0s~3600.0s	0.0s	□	F423
05.36	DI2 delay time	0.0s~3600.0s	0.0s	□	F424
05.37	DI3 delay time	0.0s~3600.0s	0.0s	□	F425
05.38	DI terminal valid mode selection 1 (DI1~DI5)	0: High level valid 1: Low level valid Bit: DI1 Ten's digit: DI2 Hundred's digit: DI3 Thousands of bits: DI4 Ten thousands of bits: DI5	00000	□	F426
05.39	DI terminal valid mode selection 2	0: High level valid 1: Low level valid Bit: Reserved Ten's digit: Reserved Hundred's digit: Reserved Thousands of bits: Reserved Ten thousands of bits: Reserved	00000	□	F427

Group 06 Output Terminals

Para. No.	Para. Name	Setting Range	Default	Modify	COM Add.
06.00	HDO terminal output mode	0: Pulse output 1: Digital output	0	◇	F500
06.01	HDO terminal function (open-collector output terminal)	0: No output 1: AC drive running 2: Fault output (stop) 3: Frequency-level detection FDT1 output 4: Frequency reached 5: Zero-speed running (no output at stop) 6: Motor overload pre-warning 7: AC drive overload pre-warning	0	◇	F501
06.02	Relay output (TA-TB-TC)	8: Set count value reached 9: Designated count value reached	2	◇	F502

Para. No.	Para. Name	Setting Range	Default	Modify	COM Add.
		10: Length reached 11: PLC cycle complete 12: Accumulative running time reached 13: Frequency limited 14: Torque limited 15: Ready for RUN 16: AII larger than AI2 17: Frequency upper limit reached 18: Frequency lower limit reached (no output at stop) 19: Under voltage state output 20: Communication setting 21: Reserved 22: Reserved 23: Zero-speed running 2 (having output at stop) 24: Accumulative power-on time reached 25: Frequency level detection FDT2 output 26: Frequency 1 reached 27: Frequency 2 reached 28: Current 1 reached 29: Current 2 reached 30: Timing reached 31: AII input limit exceeded 32: Load becoming 0 33: Reverse running 34: Zero current state 35: Module temperature reached 36: Software current limit exceeded 37: Frequency lower limit reached (having output at stop) 38: Alarm output 39: Motor overheat warning 40: Current running time reached 41: Fault output 42: Forward running 43: One-to-two control 44: High pressure arrives 45: Low pressure arrives			
06.06	HDO terminal function (High speed pulse output terminal)	0: Running frequency 1: Set frequency 2: Output current 3: Output torque 4: Output power 5: Output voltage 6: Pulse input(100% corresponds to 100.0KHz) 7: AI1 8: AI2 9: AI3 10: Length 11: Count value 12: Communication setting	0	◇	F506

Para. No.	Para. Name	Setting Range	Default	Modify	COM Add.
06.07	AO1 output function selection	13: Motor speed 14: Output current (100.0% corresponds to 1000.0A) 15: Output voltage (100.0% corresponds to 1000.0V) 16: Motor output torque (actual value, percentage relative to motor)	0	◇	F507
06.09	Maximum HDO output frequency	0.01KHz~100.00KHz	50.00KHz	◇	F509
06.10	AO1 offset coefficient	-100.0%~+100.0%	0.0%	◇	F50A
06.11	AO1 gain	-10.00~+10.00	1.00	◇	F50B
06.14	AO1 filter time	0.00s~10.00s	0.0s	◇	F50E
06.16	HDO filter time	0.00s~10.00s	0.0s	◇	F510
06.17	HDO delay time	0.0s~3600.0s	0.0s	◇	F511
06.18	Relay delay time	0.0s~3600.0s	0.0s	◇	F512
06.22	DO terminal valid state selection	0: High level valid 1: Low level valid Bit: HDO Ten's digit: TA1-TB1-TC1 Hundred's digit: Reserved Thousands of bits: Reserved Ten thousands of bits: Reserved	00000	◇	F516

Group 07 Start/Stop Control

Para. No.	Para. Name	Setting Range	Default	Modify	COM Add.
07.00	Start mode	0: Direct start 1: Rotational speed tracking restart 2: Pre-excited start (asynchronous motor)	0	◇	F600
07.01	Rotational speed tracking mode	0: From frequency at stop 1: From zero speed 2: From maximum frequency	0	□	F601
07.02	Rotational speed tracking speed	1- 100	20	◇	F602
07.03	Startup frequency	0.00- 10.00 Hz	0.00Hz	◇	F603
07.04	Startup frequency holding time	0.0- 100.0s	0.0s	□	F604
07.05	Startup DC braking current/ Pre-excited current	0%- 100%	0%	□	F605
07.06	Startup DC braking time/ Pre-excited time	0.0- 100.0s	0.0s	□	F606

Para. No.	Para. Name	Setting Range	Default	Modify	COM Add.
07.07	Acceleration/Deceleration mode	0: Linear acceleration/deceleration 1: S-curve acceleration/deceleration A 2: S-curve acceleration/deceleration B	0	<input type="checkbox"/>	F607
07.08	Time proportion of S-curve start segment	0.0% ~ (100.0%-07.09)	30.0%	<input type="checkbox"/>	F608
07.09	Time proportion of S-curve end segment	0.0% ~ (100.0%-07.08)	30.0%	<input type="checkbox"/>	F609
07.10	Stop mode	0: Decelerate to stop 1: Coast to stop	0	<input type="checkbox"/>	F60A
07.11	Initial frequency of stop DC braking	0.00Hz~Max.frequency	0.00Hz	<input type="checkbox"/>	F60B
07.12	Waiting time of stop DC braking	0.0s~100.0s	0.0s	<input type="checkbox"/>	F60C
07.13	Stop DC braking current	0%~100%	0%	<input type="checkbox"/>	F60D
07.14	Stop DC braking time	0.0s~100.0s	0.0s	<input type="checkbox"/>	F60E
07.15	Brake use ratio	0%~100%	100%	<input type="checkbox"/>	F60F

Group 08 Keyboard and Display

Para. No.	Para. Name	Setting Range	Default	Modify	COM Add.
08.01	MF.K Key function selection	0: MF.K key disabled 1: Switchover between operation panel control and remote command control (terminal or communication) 2: Switchover between forward rotation and reverse rotation 3: Forward JOG 4: Reverse JOG 5: Reverse	3	<input type="checkbox"/>	F700
08.02	STOP/RESET key function	0: STOP/RESET key enabled only in operation panel control 1: STOP/RESET key enabled in any operation mode	1	<input type="checkbox"/>	F701
08.03	LED display running parameters 1	0000~FFFF Bit00: Running frequency 1 (Hz) Bit01: Set frequency (Hz) Bit02: Bus voltage (V) Bit03: Output voltage (V) Bit04: Output current (A) Bit05: Output power (kW) Bit06: Output torque (%) Bit07: DI input status Bit08: DO output status Bit09: AI1 voltage (V) Bit10: AI2 voltage (V) Bit11: AI3 voltage (V) Bit12: Count value	0xC01F	<input type="checkbox"/>	F702

Para. No.	Para. Name	Setting Range	Default	Modify	COM Add.
		Bit13: Length value Bit14: Load speed display Bit15: PID setting			
08.04	LED display running parameters 2	0000~FFFF Bit00: PID feedback Bit01: PLC stage Bit02: Pulse setting frequency (kHz) Bit03: Running frequency 2 (Hz) Bit04: Remaining running time Bit05: AI1 voltage before correction (V) Bit06: AI2 voltage before correction (V) Bit07: Reserved Bit08: Linear speed Bit09: Current power-on time (Hour) Bit10: Current running time (Min) Bit11: Pulse setting frequency (Hz) Bit12: Communication setting value Bit13: Reserved Bit14: Main frequency A display (Hz) Bit15: Auxiliary frequency B display (Hz)	0x01	◇	F703
08.05	LED stop display parameters	0000~FFFF Bit00: Set frequency (Hz) Bit01: Bus voltage (V) Bit02: DI input status Bit03: DO output status Bit04: AI1 voltage (V) Bit05: AI2 voltage (V) Bit06: AI3 voltage (V) Bit07: Count value Bit08: Length value Bit09: PLC stage Bit10: Load speed Bit11: PID setting Bit12: Pulse setting frequency (kHz)	33	◇	F704
08.06	Load speed display coefficient	0.0001~6.5000	1.0000	◇	F705
08.07	Heatsink temperature of inverter module	0.0°C~100.0°C	-	■	F706
08.08	Temporary software version	0.0°C~100.0°C	-	■	F707
08.09	Accumulative running time	0h~65535h	-	■	F708
08.10	Product number	300	-	■	F709
08.11	Software version	-	-	■	F70A
08.12	Number of decimal places for	0: 0 decimal places 1: 1 decimal place	0	◇	F70B

Para. No.	Para. Name	Setting Range	Default	Modify	COM Add.
	load speed display	2: 2 decimal places 3: 3 decimal places			
08.13	Accumulative power-on time	0h~65535h	-	■	F70C
08.14	Accumulative power consumption	0~65535Kw*h	-	■	F70D

Group 09 Auxiliary Functions

Para. No.	Para. Name	Setting Range	Default	Modify	COM Add.
09.00	JOG running frequency	0.00Hz~Max. frequency	2.00Hz	◇	F800
09.01	JOG acceleration time	0.0s~6500.0s	20.0s	◇	F801
09.02	JOG deceleration time	0.0s~6500.0s	20.0s	◇	F802
09.03	Acceleration time 2	0.0s~6500.0s	Model determined	◇	F803
09.04	Deceleration time 2	0.0s~6500.0s	Model determined	◇	F804
09.05	Acceleration time 3	0.0s~6500.0s	Model determined	◇	F805
09.06	Deceleration time 3	0.0s~6500.0s	Model determined	◇	F806
09.07	Acceleration time 4	0.0s~6500.0s	Model determined	◇	F807
09.08	Deceleration time 4	0.0s~6500.0s	Model determined	◇	F808
09.09	Jump frequency 1	0.00 Hz to maximum frequency	0.00Hz	◇	F809
09.10	Jump frequency 2	0.00 Hz to maximum frequency	0.00Hz	◇	F80A
09.11	Frequency jump amplitude	0.00 Hz to maximum frequency	0.00Hz	◇	F80B
09.12	Forward/Reverse rotation dead-zone time	0.0~3000.0s	0.0s	◇	F80C
09.13	Reverse control	0: Enabled 1: Disabled	0	◇	F80D
09.14	Running mode when set frequency lower than frequency lower limit	0: Run at frequency lower limit 1: Stop 2: Run at zero speed	0	◇	F80E

Para. No.	Para. Name	Setting Range	Default	Modify	COM Add.
09.15	Droop control	0.00– 10.00 Hz	0.00Hz	◇	F80F
09.16	Accumulative power-on time threshold	0–65000 h	0h	◇	F810
09.17	Accumulative running time threshold	0–65000 h	0h	◇	F811
09.18	Startup protection	0: No 1: Yes	1	◇	F812
09.19	Frequency detection value (FDT1)	0.00 Hz to maximum frequency	50.00Hz	◇	F813
09.20	Frequency detection hysteresis (FDT hysteresis 1)	0.0%– 100.0% (FDT1 level)	5.0%	◇	F814
09.21	Detection range of frequency reached	0.00– 100% (maximum frequency)	0.0%	◇	F815
09.22	Jump frequency during acceleration/deceleration	0: Disabled 1: Enabled	0	◇	F816
09.25	Frequency switchover point between acceleration time 1 and acceleration time 2	0.00 Hz to maximum frequency	0.00Hz	◇	F819
09.26	Frequency switchover point between deceleration time 1 and deceleration time 2	0.00 to maximum frequency	0.00Hz	◇	F81A
09.27	Terminal JOG preferred	0: Disabled 1: Enabled	1	◇	F81B
09.28	Frequency detection value (FDT2)	0.00 to maximum frequency	50.00Hz	◇	F81C
09.29	Frequency detection hysteresis (FDT hysteresis 2)	0.0%– 100.0% (FDT2 level)	5.0%	◇	F81D
09.30	Any frequency reaching detection value 1	0.00 Hz to maximum frequency	50.00Hz	◇	F81E
09.31	Any frequency reaching detection amplitude 1	0.0%– 100.0% (maximum frequency)	0.0%	◇	F81F
09.32	Any frequency reaching detection value 2	0.00 Hz to maximum frequency	50.00Hz	◇	F820

Para. No.	Para. Name	Setting Range	Default	Modify	COM Add.
09.33	Any frequency reaching detection amplitude 2	0.0%– 100.0% (maximum frequency)	0.0%	◇	F821
09.34	Zero current detection level	0.0%–300.0% (rated motor current)	5.0%	◇	F822
09.35	Zero current detection delay time	0.00–600.00s	0.10s	◇	F823
09.36	Output overcurrent threshold	0.0% (no detection) 0.1%–300.0% (rated motor current)	200.0%	◇	F824
09.37	Output overcurrent detection delay time	0.00–600.00s	0.00s	◇	F825
09.38	Any current reaching 1	0.0%–300.0% (rated motor current)	100.0%	◇	F826
09.39	Any current reaching 1 amplitude	0.0%–300.0% (rated motor current)	0.0%	◇	F827
09.40	Any current reaching 2	0.0%–300.0% (rated motor current)	100.0%	◇	F828
09.41	Any current reaching 2 amplitude	0.0%–300.0% (rated motor current)	0.0%	◇	F829
09.42	Timing function	0: Disabled 1: Enabled	0	◇	F82A
09.43	Timing duration source	0: 09.44 1: AI1 2: AI2 3: Reserved (100% of analog input corresponds to the value of 09.44)	0	◇	F82B
09.44	Timing duration	0.0–6500.0 min	0.0Min	◇	F82C
09.45	AI1 input voltage lower limit	0.00 V to 09.46	3.10V	◇	F82D
09.46	AI1 input voltage upper limit	09.45 to 10.00 V	6.80V	◇	F82E
09.47	Module temperature threshold	0– 100°C	75°C	◇	F82F
09.48	Cooling fan control	0: Fan working during running 1: Fan working continuously	0	◇	F830
09.49	Current running time reached	0.0Min~6500.0Min	0.0Min	◇	F831

Group 10 Faults and Protections

Para. No.	Para. Name	Setting Range	Default	Modify	COM Add.
10.00	Motor overload protection selection	0: Disabled 1: Enabled	1	◇	F900
10.01	Motor overload protection gain	0.20~10.00	1.00	◇	F901
10.02	Motor overload warning coefficient	50%~100%	80%	◇	F902

Para. No.	Para. Name	Setting Range	Default	Modify	COM Add.
10.03	Overvoltage stall gain	0~100	30	◇	F903
10.04	Overvoltage stall protective voltage	650V~800V	760V	◇	F904
10.05	Overcurrent stall gain	0~100	20	◇	F905
10.06	Overcurrent stall protective current	100%~200%	150%	◇	F906
10.07	Short-circuit to ground upon power-on	0: Disabled 1: Enabled	1	◇	F907
10.08	Braking unit action starting	200.0~2000.0V	690.0V	◇	F908
10.09	Fault auto reset times	0~20	0	◇	F909
10.10	DO action during fault auto reset	0: no action 1: Action	0	◇	F90A
10.11	Time interval of fault auto	0.1s~100.0s	1.0s	◇	F90B
10.12	Input phase loss protection/ contactor energizing protection selection	10: Prohibit 11: Allow	11	◇	F90C
10.13	Output phase loss protection selection	0: Prohibit 1: Allow	1	◇	F90D
10.14	1st fault type	0: No fault 1: Reserved	E.XXX	■	F90E
10.15	2nd fault type	2: Overcurrent during acceleration 3: Overcurrent during deceleration 4: Overcurrent at constant speed	E.XXX	■	F90F

Para. No.	Para. Name	Setting Range	Default	Modify	COM Add.
10.16	3rd (latest) fault type	5: Overvoltage during acceleration 6: Overvoltage during deceleration 7: Overvoltage at constant speed 8: Buffer resistance overload 9: Under voltage 10: AC drive overload 11: Motor overload 12: Power input phase loss 13: Power output phase loss 14: Module overheat 15: External equipment fault 16: Communication fault 17: Contactor fault 18: Current detection fault 19: Motor auto-tuning fault 20: Encoder/PG card fault 21: EEPROM read-write fault 22: AC drive hardware fault 23: Short circuit to ground 24: Reserved 25: Reserved 26: Accumulative running time reached 27: User-defined fault 1 28: User-defined fault 2 29: Accumulative power-on time reached 30: Load becoming 0 31: PID feedback lost during running 40: With-wave current limit fault 41: Motor switchover fault during running 42: Too large speed deviation 43: Motor over-speed 45: Motor overheat 51: Initial position fault	E.XXX	■	F910
10.17	Frequency upon 3rd fault	—	Hz	■	F911
10.18	Current upon 3rd fault	—	A	■	F912
10.19	Bus voltage upon 3rd fault	—	V	■	F913
10.20	DI status upon 3rd fault	—	—	■	F914
10.21	Output terminal status upon 3rd fault	—	—	■	F915
10.22	AC drive status upon 3rd fault	—	—	■	F916
10.23	Power-on time upon 3rd fault	—	s	■	F917
10.24	Running time upon 3rd fault	—	s	■	F918
10.27	Frequency upon 2nd fault	—	Hz	■	F91B

Para. No.	Para. Name	Setting Range	Default	Modify	COM Add.
10.28	Current upon 2nd fault	—	A	■	F91C
10.29	Bus voltage upon 2nd fault	—	V	■	F91D
10.30	DI status upon 2nd fault	—	—	■	F91E
10.31	DO status upon 2nd fault	—	—	■	F91F
10.32	AC drive state upon 2nd fault	—	—	■	F920
10.33	Power-on time upon 2nd fault	—	s	■	F921
10.34	Running time upon 2nd fault	—	s	■	F922
10.37	Frequency upon 1st fault	—	Hz	■	F925
10.38	Current upon 1st fault	—	A	■	F926
10.39	Bus voltage upon 1st fault	—	V	■	F927
10.40	DI state upon 1st fault	—	—	■	F928
10.41	DO state upon 1st fault	—	—	■	F929
10.42	AC drive state upon 1st fault	—	—	■	F92A
10.43	Power-on time upon 1st fault	—	s	■	F92B
10.44	Running time upon 1st fault	—	s	■	F92C
10.47	Fault protection action selection 1	Bit: Motor overload (FU11) 0: Free parking 1: Stop by stop mode 2: continue to run Ten bit: input phase loss (FU12) (reserved) Hundreds bit: output phase loss (FU13) Thousands bit: External Fault (FU15) Ten thousands bit: communication error (FU16)	00000	◇	F92F
10.48	Fault protection action selection 2	Bit: keep(FU 20) 0: Free parking Ten bit: function code read and write exception (FU21) 0: Free parking 1: Stop by stop mode Hundreds bit: Inverter overload fault action selection (FU10) 0: Free stop 1: derating operation Thousands bit: Motor overheating (FU45) Ten thousands bit: Run time arrives (FU26)	00000	◇	F930

Para. No.	Para. Name	Setting Range	Default	Modify	COM Add.
10.49	Fault protection action selection 3	Bit: User-defined fault 1 (FU27) 0: Free parking 1: stop according to the stop mode 2: keep running Tens bit: User-defined fault 2 (FU28) 0: Free parking 1: stop according to the stop mode 2: keep running Hundreds bit: the power-on time arrives (FU29) 0: Free parking 1: stop according to the stop mode 2: keep running Thousands bit: drop load (FU30) 0: Free parking 1: Decelerate to stop 2: Decelerate to 7% of the rated frequency of the motor and continue to run OK, it will automatically return to the set frequency operation when the load is not dropped. Ten thousand bit: PID feedback lost during runtime (FU31) 0: Free parking 1: stop according to the stop mode 2: keep running	00000	◇	F931
10.50	Fault protection action selection 4	Bit: Speed deviation is too large (FU42) 0: Free parking 1: Stop by stop mode 2: continue to run Ten bit: motor over speed (FU43) Hundreds bit: initial position error (FU51)	00000	◇	F932
10.54	Frequency selection for continuing to run upon fault	0: Run at the current operating frequency 1: run at the set frequency 2: Run at the upper limit frequency 3: Run at the following frequency limit 4: Run at abnormal backup frequency(10.55)	0	◇	F936
10.55	Backup frequency upon abnormality	0.0%– 100.0% (maximum frequency)	100.0%	◇	F937
10.56	Type of motor temperature sensor	0: No temperature sensor 1: PT100 2: PT1000	0	◇	F938
10.57	Motor overheat protection threshold	0–200°C	110°C	◇	F939

Para. No.	Para. Name	Setting Range	Default	Modify	COM Add.
10.58	Motor overheat warning threshold	0–200°C	90°C	◇	F93A
10.59	Action selection at instantaneous power failure	0: Invalid 1: Decelerate 2: Decelerate to stop	0	◇	F93B
10.60	Action pause judging voltage at instantaneous power failure	80.0%– 100.0%	100.0%	◇	F93C
10.61	Voltage rally judging time at instantaneous power failure	0.00– 100.00s	0.50s	◇	F93D
10.62	Action judging voltage at instantaneous power failure	60.0%– 100.0% (standard bus voltage)	80.0%	◇	F93E
10.63	Protection upon load becoming 0	0: Disabled 1: Enabled	0	◇	F93F
10.64	Detection level of load becoming 0	0.0%– 100.0% (rated motor current)	10.0%	◇	F940
10.65	Detection time of load becoming 0	0.0–60.0s	1.0s	◇	F941
10.66	Inverter overheating pre-alarm threshold setting	0.0°C~ 150.0°C	95°C	◇	F942
10.67	Over-speed detection value	0.0%–50.0% (maximum frequency)	20.0%	◇	F943
10.68	Over-speed detection time	0.0–60.0s	5.0s	◇	F944
10.69	Detection value of too large speed deviation	0.0%–50.0% (maximum frequency)	20.0%	◇	F945
10.70	Detection time of too large speed deviation	0.0–60.0s	0.0s	◇	F946

Group 11 PID functions

Para. No.	Para. Name	Setting Range	Default	Modify	COM Add.
11.00	PID setting source	0: 11.01 set 1: AI1 2: AI2 3: Reserved 4: Pulse setting (DI5) 5: Communication setting 6: Multi-reference 7: keyboard potentiometer	7	◇	FA00
11.01	PID digital setting	0.0~100.0Bar	3.0Bar	◇	FA01

Para. No.	Para. Name	Setting Range	Default	Modify	COM Add.
11.02	PID feedback source	0: AI1 1: AI2 2: Reserved 3: AI1-AI2 4: Pulse setting (DI5) 5: Communication setting 6: AI1 + AI2 7: MAX (AI1 , AI2) 8: MIN (AI1 , AI2)	0	◇	FA02
11.03	PID action direction	0: Forward action 1: Reverse action	0	◇	FA03
11.04	PID setting feedback range	0-65535	10.0Bar	◇	FA04
11.05	Proportional gain Kp1	0.0- 100.0	20.0	◇	FA05
11.06	Integral time Ti1	0.01- 10.00s	1.00s	◇	FA06
11.07	Differential time Td1	0.00- 10.000	0.000s	◇	FA07
11.08	Cut-off frequency of PID reverse rotation	0.00 to maximum frequency	0.00Hz	◇	FA08
11.09	PID deviation limit	0.0%- 100.0%	0.0%	◇	FA09
11.10	PID differential limit	0.00%- 100.00%	0.10%	◇	FA0A
11.11	PID setting change time	0.00-650.00s	0.00s	◇	FA0B
11.12	PID feedback filter time	0.00-60.00s	0.00s	◇	FA0C
11.13	PID output filter time	0.00-60.00s	0.00s	◇	FA0D
11.14	Reserved	-	0.0%	◇	FA0E
11.15	Proportional gain Kp2	0.0- 100.0	20.0	◇	FA0F
11.16	Integral time Ti2	0.01- 10.00s	1.00s	◇	FA10
11.17	Differential time Td2	0.000- 10.000s	0.000s	◇	FA11
11.18	PID parameter switchover condition	0: No switchover 1: Switchover via DI 2: Automatic switchover based on deviation	0	◇	FA12
11.19	PID parameter switchover deviation 1	0.0% to 11.20	20.0%	◇	FA13
11.20	PID parameter switchover deviation 2	11.19 to 100.0%	80.0%	◇	FA14
11.21	PID initial value	0.0%- 100.0%	0.0%	◇	FA15
11.22	PID initial value holding time	0.00-650.00s	0.00s	◇	FA16
11.23	Maximum deviation between two PID outputs in forward direction	0.00%- 100.00%	1.00%	◇	FA17

Para. No.	Para. Name	Setting Range	Default	Modify	COM Add.
11.24	Maximum deviation between two PID outputs in REVERSE direction	0.00%~100.00%	1.00%	◇	FA18
11.25	PID integral property	Bit: integral separation 0: invalid 1: valid Ten Bit: Whether to stop the integration after outputting to the limit 0: Continue to score 1: stop the points	00	◇	FA19
11.26	Detection level of PID feedback loss	0.0%: No detection 0.1% to 100.0%	0.0%	◇	FA1A
11.27	Detection time of PID feedback loss	0.0s to 20.0s	0.0s	◇	FA1B
11.28	Selection of PID operation at stop	0: Operation at stopped 1: Operation at stop	0	◇	FA1C

Group 12 Swing Frequency, Fixed Length and Count

Para. No.	Para. Name	Setting Range	Default	Modify	COM Add.
12.00	Swing frequency setting mode	0: Relative to the central frequency 1: Relative to the maximum frequency	0	◇	FB00
12.01	Swing frequency amplitude	0.0%~100.0%	0.0%	◇	FB01
12.02	Jump frequency amplitude	0.0%~50.0%	0.0%	◇	FB02
12.03	Swing frequency cycle	0.1s~3000.0s	10.0s	◇	FB03
12.04	Triangular wave rising time coefficient	0.1%~100.0%	50.0%	◇	FB04
12.05	Set length	0m~65535m	1000m	◇	FB05
12.06	Actual length	0m~65535m	0m	◇	FB06
12.07	Number of pulses per meter	0.1~6553.5	100.0	◇	FB07
12.08	Set count value	1~65535	1000	◇	FB08
12.09	Designated count value	1~65535	1000	◇	FB09

Group 13 Multi-Reference and Simple PLC Function

Para. No.	Para. Name	Setting Range	Default	Modify	COM Add.
13.00	Reference 0	-100.0%~100.0%	0.0%	◇	FC00
13.01	Reference 1	-100.0%~100.0%	0.0%	◇	FC01
13.02	Reference 2	-100.0%~100.0%	0.0%	◇	FC02
13.03	Reference 3	-100.0%~100.0%	0.0%	◇	FC03
13.04	Reference 4	-100.0%~100.0%	0.0%	◇	FC04
13.05	Reference 5	-100.0%~100.0%	0.0%	◇	FC05
13.06	Reference 6	-100.0%~100.0%	0.0%	◇	FC06

Para. No.	Para. Name	Setting Range	Default	Modify	COM Add.
13.07	Reference 7	-100.0% ~ 100.0%	0.0%	◇	FC07
13.08	Reference 8	-100.0% ~ 100.0%	0.0%	◇	FC08
13.09	Reference 9	-100.0% ~ 100.0%	0.0%	◇	FC09
13.10	Reference 10	-100.0% ~ 100.0%	0.0%	◇	FC0A
13.11	Reference 11	-100.0% ~ 100.0%	0.0%	◇	FC0B
13.12	Reference 12	-100.0% ~ 100.0%	0.0%	◇	FC0C
13.13	Reference 13	-100.0% ~ 100.0%	0.0%	◇	FC0D
13.14	Reference 14	-100.0% ~ 100.0%	0.0%	◇	FC0E
13.15	Reference 15	-100.0% ~ 100.0%	0.0%	◇	FC0F
13.16	Simple PLC running mode	0: Stop after the AC drive runs one cycle 1: Keep final values after the AC drive runs one cycle 2: Repeat after the AC drive runs one cycle	0	◇	FC10
13.17	Simple PLC retentive selection	Bit: Memory selection when power off 0: No memory when power off 1: Memory when power off Tens bit: memory selection during stop 0: No memory when stopped 1: Memory when stopped	00	◇	FC11
13.18	Running time of simple PLC reference 0	0.0s (h) ~6500.0 (h)	0.0s(h)	◇	FC12
13.19	Acceleration/deceleration time of simple PLC reference 0	0~3	0	◇	FC13
13.20	Running time of simple PLC reference 1	0.0s (h) ~6500.0 (h)	0.0s(h)	◇	FC14
13.21	Acceleration/deceleration time of simple PLC reference 1	0~3	0	◇	FC15
13.22	Running time of simple PLC reference 2	0.0s (h) ~6500.0 (h)	0.0s(h)	◇	FC16
13.23	Acceleration/deceleration time of simple PLC reference 2	0~3	0	◇	FC17
13.24	Running time of simple PLC reference 3	0.0s (h) ~6500.0 (h)	0.0s(h)	◇	FC18
13.25	Acceleration/deceleration time of simple PLC reference 3	0~3	0	◇	FC19
13.26	Running time of simple PLC reference 4	0.0s (h) ~6500.0 (h)	0.0s(h)	◇	FC1A
13.27	Acceleration/deceleration time of simple PLC reference 4	0~3	0	◇	FC1B
13.28	Running time of simple PLC reference 5	0.0s (h) ~6500.0 (h)	0.0s(h)	◇	FC1C
13.29	Acceleration/deceleration time of simple PLC reference 5	0~3	0	◇	FC1D
13.30	Running time of simple PLC reference 6	0.0s (h) ~6500.0 (h)	0.0s(h)	◇	FC1E

Para. No.	Para. Name	Setting Range	Default	Modify	COM Add.
13.31	Acceleration/deceleration time of simple PLC reference 6	0~3	0	◇	FC1F
13.32	Running time of simple PLC reference 7	0.0s (h) ~6500.0 (h)	0.0s(h)	◇	FC20
13.33	Acceleration/deceleration time of simple PLC reference 7	0~3	0	◇	FC21
13.34	Running time of simple PLC reference 8	0.0s (h) ~6500.0 (h)	0.0s(h)	◇	FC22
13.35	Acceleration/deceleration time of simple PLC reference 8	0~3	0	◇	FC23
13.36	Running time of simple PLC reference 9	0.0s (h) ~6500.0 (h)	0.0s(h)	◇	FC24
13.37	Acceleration/deceleration time of simple PLC reference 9	0~3	0	◇	FC25
13.38	Running time of simple PLC reference 10	0.0s (h) ~6500.0 (h)	0.0s(h)	◇	FC26
13.39	Acceleration/deceleration time of simple PLC reference 10	0~3	0	◇	FC27
13.40	Running time of simple PLC reference 11	0.0s (h) ~6500.0 (h)	0.0s(h)	◇	FC28
13.41	Acceleration/deceleration time of simple PLC reference 11	0~3	0	◇	FC29
13.42	Running time of simple PLC reference 12	0.0s (h) ~6500.0 (h)	0.0s(h)	◇	FC2A
13.43	Acceleration/deceleration time of simple PLC reference 12	0~3	0	◇	FC2B
13.44	Running time of simple PLC reference 13	0.0s (h) ~6500.0 (h)	0.0s(h)	◇	FC2C
13.45	Acceleration/deceleration time of simple PLC reference 13	0~3	0	◇	FC2D
13.46	Running time of simple PLC reference 14	0.0s (h) ~6500.0 (h)	0.0s(h)	◇	FC2E
13.47	Acceleration/deceleration time of simple PLC reference 14	0~3	0	◇	FC2F
13.48	Running time of simple PLC reference 15	0.0s (h) ~6500.0 (h)	0.0s(h)	◇	FC30
13.49	Acceleration/deceleration time of simple PLC reference 15	0~3	0	◇	FC31
13.50	Time unit of simple PLC running	0: s (second) 1:h (hour)	0	◇	FC32
13.51	Reference 0 source	0: Set by 13.00 1: AI1 2: AI2 3: AI3 keyboard potentiometer 4: Pulse setting 5: PID 6: Set by preset frequency (01. 08), modified via terminal UP/ DOWN	7	◇	FC33

Group 14 Communication Parameters

Para. No.	Para. Name	Setting Range	Default	Modify	COM Add.
14.00	Baud rate	Bit: MODBUS 0: 300BPS 1: 600BPS 2: 1200BPS 3: 2400BPS 4: 4800BPS 5: 9600BPS 6: 19200BPS 7: 38400BPS 8: 57600BPS Ten bit: Profibus-DP 0: 115200BPS 1: 208300BPS 2: 256000BPS 3: 512000Bps Hundred's bit:Reserved Thousand's bit (CANlink baud rate) 0: 20 1: 50 2: 100 3: 125 4: 250 5: 500 6: 1M	6005	◇	FD00
14.01	MODBUS data format	0: No parity (8-N-2) 1: Even check (8-E-1) 2: Odd parity (8-O-1) 3: No parity (8-N-1)	0	◇	FD01
14.02	Local address	0: Broadcast address; 1 to 247	1	◇	FD02
14.03	MODBUS response delay	0ms~20ms	2	◇	FD03
14.04	Communication timeout	0.0: invalid 0.1s to 60.0s	0.0	◇	FD04
14.05	Modbus protocol selection	Bit: MODBUS 0: non-standard MODBUS protocol 1: Standard MODBUS protocol Ten bit:Reserved	31	◇	FD05
14.06	Current resolution read by communication	0: 0.01 1: 0.1	0	◇	FD06
14.07	Communication master-slave mode	0: Slave 1: Mater	0	◇	FD07

Group 15~16 Reserved

Group 17 Function Code Management

Para. No.	Para. Name	Setting Range	Default	Modify	COM Add.
17.00	User password	0~65535	0	◇	1F00

Para. No.	Para. Name	Setting Range	Default	Modify	COM Add.
17.01	Parameter initialization	0: No operation 1: Restore factory parameters except motor parameters 2: Clear records 4: Back up current user parameters 501: Restore user backup parameters	0	◇	1F01
17.02	Parameter display property	Bit: 00 group display selection 0: Not displayed 1: Display Ten: Group(18~30) display the selection 0: Not displayed 1: Display	11	◇	1F02
17.03	Selection of individualized parameter display	Bit: User custom parameter group display selection 0: Not displayed 1: Display Ten bit: User Change Parameter Group Display Selection 0: Not displayed 1: Display	00	◇	1F03
17.04	Selection of parameter modification	0: Can be modified 1: Cannot be modified	0	◇	1F04

Group18~22 Reserved

Group 23 Control Optimization Parameters

Para. No.	Para. Name	Setting Range	Default	Modify	COM Add.
23.00	DPWM switchover frequency upper limit	0.00– 15.00 Hz	8.00Hz	◇	A500
23.01	PWM modulation mode	0: Asynchronous modulation 1: Synchronous modulation	0	◇	A501
23.02	Dead zone compensation mode selection	0: No compensation 1: Compensation mode 1 2: Compensation mode 2	1	◇	A502
23.03	Random PWM depth	0: Random PWM invalid 1-10	0	◇	A503
23.04	Rapid current limit	0: Disabled 1: Enabled	1	◇	A504
23.05	Current detection compensation	0- 100	5	◇	A505
23.06	Under voltage threshold	60.0%– 140.0%	100%	◇	A506
23.07	SVC optimization mode selection	0: No optimization 1: Optimization mode 1 2: Optimization mode 2	2	◇	A507
23.08	Dead-zone time adjustment	100%–200%	150%	◇	A508
23.09	Overvoltage threshold	200.0–2500.0 V	800.0V	◇	A509

Para. No.	Para. Name	Setting Range	Default	Modify	COM Add.
23.10	Low frequency variable carrier enable	0-1	1	◇	A509
23.11	Zero speed running output enable	0-1	1	◇	A510
23.12	Power phase loss protection sensitivity	0-30.0%	13%	◇	A511

Chapter 6: Parameter Description

Group 00 Monitoring parameter group

The 00 parameter group is used to monitor the operating status information of the inverter. The customer can view it through the panel to facilitate on-site debugging, and can also read the parameter group value through communication for monitoring by the host computer.

The communication address is 0x7000~0x7044.

Among them, 00.00~00.31 are the running and stop monitoring parameters defined in 08.03 and 08.04.

00.0 0	Running frequency(Hz)	Display range	0.00~500.00Hz(01.22=2)
00.0 1	Setting frequency(Hz)		0.00~500.00Hz(01.22=1)

Displays the theoretical running frequency of the inverter and the absolute value of the set frequency.

For the actual output frequency of the inverter, see 00.19

00.02	DC bus voltage(V)	Display range	0.0V~3000.0V
-------	-------------------	---------------	--------------

Display the inverter bus voltage value

00.03	The output voltage(V)	Display range	0V~1140V
-------	-----------------------	---------------	----------

Display the output voltage value of the inverter during operation

00.04	The output current(V)	Display range	0.00A~655.35A (≤55KW) 0.0A~6553.5A (>55KW)
-------	-----------------------	---------------	---

Display the output current value of the inverter during operation

00.05	The output power(kW)	Display range	0~32767
-------	----------------------	---------------	---------

The calculated value of actual output power of motor

00.06	Output torque(%)	Display range	-200.0% ~ 200.0%
-------	------------------	---------------	------------------

Display the output torque value of the inverter during operation

00.07	DI input status	Display range	0~ 32767
-------	-----------------	---------------	----------

Displays the current X terminal input state value in hexadecimal. After conversion into binary data, each bit corresponds to the X input signal, 1 indicates that the input is a high-level signal, and 0 indicates that the input is a low-level signal. The corresponding relationship between each bit and the input terminal is as follows:

Bit0	Bit1	Bit2	Bit3
DI1	DI2	DI3	DI4
Bit4	Bit5	Bit6	Bit7
DI5	-	-	-

00.08	DO output status	Display range	0~1023
-------	------------------	---------------	--------

Displays the current DO terminal output status value in hexadecimal. After conversion into binary data, each bit corresponds to a DO signal, 1 means the output is high, and 0 means the output is low. The correspondence between each bit and DO is as follows:

Bit0	Bit1	Bit2	Bit3
-	Relay 1	-	HDO

00.10	A11 voltage) /current (mA)	Display range	0.00V~10.57V 0.00mA~20.00mA
-------	----------------------------	---------------	--------------------------------

When 05.40 is set to 0, the A11 sampling data display unit is voltage (V)

When 05.40 is set to 1, A11 sampling data display unit is current (mA)

00.14	Load speed display	Display range	0~65535
-------	--------------------	---------------	---------

See 08.12 for details.

00.15	PID set	Display range	0~65535
00.16	PID feedback	Display range	0~65535

Display PID set value and feedback value, the value format is as follows:

PID setting=PID setting (percent)*11.04

PID feedback=PID feedback (percent)*11.04

00.18	PULSE pulse input frequency(kHz)	Display range	0.00kHz~100.00KHz
-------	----------------------------------	---------------	-------------------

Display DI5 high-speed pulse sampling frequency, the minimum unit is 0.01KHz

00.19	Feedback speed	Display range	-320.00Hz~320.00Hz -500.0Hz~500.0Hz
-------	----------------	---------------	--

Display the actual output frequency of the inverter

The ten-digit setting value of function code 08.12 (load speed display decimal point) indicates the number of decimal points in 00.19/00.29,

When it is set to 2, the number of decimal points in 00.19 is 2, and the Display range is -320.00Hz~320.00Hz;

When it is set to 1, the number of decimal points in 00.19 is 1, and the Display range is -500.0Hz to 500.0Hz.

00.20	Surplus remaining time	Display range	0.0~6500.0min
-------	------------------------	---------------	---------------

Displays the remaining run time of the timing run

For the introduction of timing operation, see the introduction of parameters 09.42~09.44

00.21	AI1 voltage before correction	Display range	0.000V~10.570V
00.22	AI2 voltage/Current before correction	Display range	0.000V~10.570V 0.000mA~20.000mA

Displays the actual value of the analog input sampled voltage/current.

The actual voltage/current used is linearly corrected to make the deviation between the sampled voltage/current and the actual input voltage/current smaller.

See 00.09, 00.10, 00.11 for the actual correction voltage/current used.

00.24	Linear velocity	Display range	0~65535 m/min
-------	-----------------	---------------	---------------

Displays the linear velocity of the DI5 high-speed pulse sampling, in m/min

Calculate the linear velocity value according to the actual number of sampled pulses per minute and 12.07 (pulses per meter)

00.27	PULSE input frequency	Display range	0~65535Hz
-------	-----------------------	---------------	-----------

Display the DI5 high-speed pulse sampling frequency, the unit is 1Hz. It is the same data as 00.18, only the displayed unit is different

00.28	Communication set value	Display range	-100.00%~100.00%
-------	-------------------------	---------------	------------------

Display data written through communication address 0x1000

00.30	Main frequency X display	Display range	0.00Hz~320.00Hz 0.0Hz~3200.0Hz
-------	--------------------------	---------------	-----------------------------------

Main frequency source set frequency

00.31	Auxiliary frequency Y display	Display range	0.00Hz~320.00Hz 0.0Hz~3200.0Hz
-------	-------------------------------	---------------	-----------------------------------

Auxiliary frequency source set frequency

00.35	Target torque(%)	Display range	-200.0% ~ 200.0%
-------	------------------	---------------	------------------

Display the current torque upper limit set value

00.39	VF separation target voltage	Display range	0V~Motor rated voltage
00.40	VF separation output voltage	Display range	0V~Motor rated voltage

Displays the target output voltage and the current actual output voltage when operating in the VF separation state

For the VF separation mode, please refer to the related introduction of the 04 group.

00.41	DI input status display	Display range	-
-------	-------------------------	---------------	---

Visually display the DI terminal status, the display format is as follows:

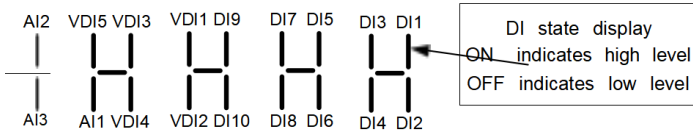

00.42	DO output status display	Display range	-
-------	--------------------------	---------------	---

Visually display the DO terminal status, the display format is as follows:

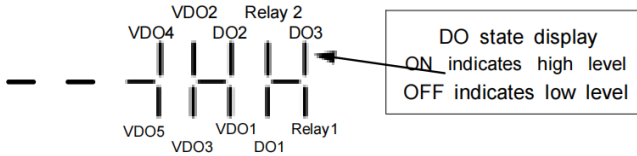

00.43	DI function status display1	Display range	-
-------	-----------------------------	---------------	---

Visually display whether terminal functions 1 to 40 are valid

There are 5 digital tubes on the keyboard, and each digital tube display can represent 8 function options

The definition of digital tube is as follows:

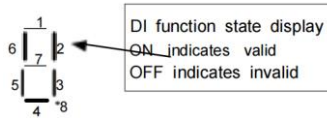

The digital tubes represent functions from right to left:

1~8、9~16、17~24、25~32、33~40

00.44	DI function status display2	Display range	-
-------	-----------------------------	---------------	---

Visually display whether terminal functions 41 to 59 are valid

The display is similar to 00.43

The digital tubes represent functions 41-48, 49-56, 57-59 from right to left respectively

00.58	Z signal counter	Display range	0 ~ 65535
-------	------------------	---------------	-----------

Display current ABZ or UVW encoder Z-phase pulse count

When the encoder rotates forward or reverse every time, the corresponding value is added or subtracted by 1.

Check the value to check whether the encoder is installed normally.

00.59	Set frequency	Display range	-100.00% ~ 100.00%
-------	---------------	---------------	--------------------

00.60	running frequency	Display range	-100.00% ~ 100.00%
-------	-------------------	---------------	--------------------

Display the current set frequency and running frequency, 100.00% corresponds to the maximum frequency of the inverter (01.10)

00.61	Inverter running status	Display range	0 ~ 65535
-------	-------------------------	---------------	-----------

Display inverter running status information, the data definition format is as follows:

00.61	Bit0	0 : STOP ; 1 : FWD ; 2 : REV
	Bit1	
	Bit2	0 : Constant ; 1 : Accelerate ; 2 : Decelerate
	Bit3	
	Bit4	0 : DC Bus normal ; 1 : Under-voltage

00.62	Current fault code	Display range	0 ~ 99
-------	--------------------	---------------	--------

Group 01 Basic Function Group

01.00	GP type display		Default	Model dependent
	Setting Range	1	G type (constant torque load)	
		2	P type (variable torque load e.g. fan and pump)	

This parameter is used to display the delivered model and cannot be modified

1: Applicable to constant torque load with rated parameters specified

2: Applicable to variable torque load (fan and pump) with rated parameters specified

01.01	Motor 1 control		Default	0
	Setting Range	0	Sensor less flux vector control (SVC)	
		1	Reserved	
		2	Voltage/Frequency (V/F) control	

0: Sensor less flux vector control (SVC)

It indicates open-loop vector control, and is applicable to high-performance control applications such as machine tool, centrifuge, wire drawing machine and injection molding machine. One AC drive can operate only one motor.

1: Reserved

2: Voltage/Frequency (V/F) control

It is applicable to applications with low load requirements or applications where one AC drive operates multiple motors, such as fan and pump.

Note: If vector control is used, motor auto-tuning must be performed because the advantages of vector control can only be utilized after correct motor parameters are obtained. Better performance can be achieved by adjusting speed regulator parameters in group 02 (or groups A2, A3, and A4 respectively for motor 2, 3, and 4).

01.02	Command source selection		Default	0
	Setting Range	0	Operation panel control (LED off)	
		1	Terminal control (LED on)	
		2	Communication control (LED blinking)	

It is used to determine the input channel of the AC drive control commands, such as run, stop, forward rotation, reverse rotation and jog operation.

0: Operation panel control channel (“LOCAL/REMOT” indicator off)

Commands are given by pressing keys “RUN” and “STOP/RES” on the operation panel

1: Terminal control (“LOCAL/REMOT” indicator on)

Commands are given by means of multifunctional input terminals with functions such as FWD, REV, JOGF, and JOGR.

2: Communication control channel (“LOCAL/REMOT” indicator blinking)

Commands are given from host computer.

01.03	Main frequency source selection X		Default	0
	Setting Range	0	Digital setting (Preset frequency 01.08, UP/DOWN adjustable, non-retentive at power failure)	
		1	Digital setting (Preset frequency 01.08, UP/DOWN adjustable, retentive at power failure)	
		2	AI1	
		3	AI2	
		4	AI3 (keyboard potentiometer)	

	5	Pulse setting (DI5)
	6	Multi-reference
	7	PLC
	8	PID
	9	Communication setting

It is used to select the setting channel of the main frequency. You can set the main frequency in the following 10 channels:

0: Digital setting (non-retentive at power failure)

The initial value of the set frequency is the value of 01.08 (Preset frequency). You can change the set frequency by pressing ▲ and ▼ on the operation panel (or using the UP/DOWN functions of input terminals).

When the AC drive is powered on again after power failure, the set frequency reverts to the value of 01.08.

1: Digital setting (retentive at power failure)

The initial value of the set frequency is the value of 01.08 (Preset frequency). You can change the set frequency by pressing keys ▲ and ▼ on the operation panel (or using the UP/DOWN functions of input terminals).

When the AC drive is powered on again after power failure, the set frequency is the value memorized at the moment of the last power failure.

Note that 01.23 (Retentive of digital setting frequency upon power failure) determines whether the set frequency is memorized or cleared when the AC drive stops. It is related to stop rather than power failure.

2: AI1

3: AI2

4: AI3 (keyboard potentiometer)

5: Pulse setting (DI5)

The frequency is set by DI5 (high-speed pulse). The signal specification of pulse setting is 9–30 V (voltage range) and 0–100 kHz (frequency range). Input pulse can only be given from multifunctional input terminals DI5. The relation between DI5 terminal input pulse frequency and the corresponding set, is designed through the 05.28~05.31, the corresponding relation of two points is straight line corresponding relation. The corresponding value 100% of pulse setting corresponds to the value of 01.10 (Maximum frequency).

6: Multi-reference

In multi-reference mode, combinations of different DI terminal states correspond to different set frequencies. The DSI-100 supports a maximum of 16 speeds implemented by 16 state combinations of four DI terminals (allocated with functions 12 to 15) in Group PC. The multiple references indicate percentages of the value of 01.10 (Maximum frequency).

If a DI terminal is used for the multi-reference function, you need to perform related setting in group 04.

7. Simple PLC

When the frequency source is a simple PLC, the operating frequency source of the inverter can be switched between 1 to 16 arbitrary frequency commands. The holding time and the respective acceleration and deceleration time of the 1 to 16 frequency commands can also be set by the user. For details, please refer to Instructions for PC groups.

8. PID

Select the output of the process PID control as the operating frequency. Generally used for on-site process closed-loop control, such as constant pressure closed-loop control, constant tension closed-loop control and other occasions.

When using PID as the frequency source, it is necessary to set the relevant parameters of the "PID function" of the PA group.

9. Communication given

Refers to the frequency given by the communication method.

01.04	Auxiliary frequency source		Default	0
	Setting Range	0	Digital setting (Preset frequency 01.08, UP/DOWN adjustable, non-retentive at power failure)	
		1	Digital setting (Preset frequency 01.08, UP/DOWN adjustable, retentive at power failure)	
		2	AI1	
		3	AI2	
		4	AI3 (keyboard potentiometer)	
		5	Pulse setting (DI5)	
		6	Multi-reference	
		7	PLC	
		8	PID	
9	Communication setting			

When the auxiliary frequency source is used as an independent frequency reference channel (that is, the frequency source is selected as X to Y switching), its usage is the same as that of the main frequency source X. For the usage method, please refer to the relevant instructions in 01.03.

When the auxiliary frequency source is used as the superposition reference (that is, the composite realization frequency reference of the main frequency source X and the auxiliary frequency source Y), it is necessary to pay attention to:

1. When the auxiliary frequency source is a digital reference, the preset frequency (01.08) does not work. The frequency adjustment by the user through the ▲ and ▼ keys of the keyboard (or the UP and DOWN of the multi-function input terminal) is directly in the main reference. adjusted on a frequency basis.

2. When the auxiliary frequency source is given by analog input (AI1, AI2) or pulse input, 100% of the input setting corresponds to the range of auxiliary frequency source, which can be set by 01.05 and 01.06.

3. When the frequency source is pulse input given, it is similar to analog given.

Tip: The auxiliary frequency source Y selection and the main frequency source X selection cannot be set to the same channel, that is, 01.03 and 01.04 should not be set to the same value, otherwise it will easily cause confusion.

01.05	Range of auxiliary frequency Y for X and Y		Default	0
	Setting Range	0	Relative to maximum frequency	
1		Relative to main frequency X		
01.06	Range of auxiliary frequency Y for X and Y		Default	0
	Setting Range		0% ~ 150%	

When the frequency source is selected as "frequency superposition" (ie 08 is set to 1, 3 or 4), these two parameters are used to determine the adjustment range of the auxiliary frequency source.

01.05 is used to determine the object corresponding to the auxiliary frequency source range. It can be selected relative to the maximum frequency or relative to the main frequency source X. If it is selected to be relative to the main frequency source, the range of the auxiliary frequency source will follow the main frequency X. changes with the

01.07	Frequency source selection		Default	0
	Setting Range	Unit's digit	Frequency source selection	
		0	Main frequency source X	
		1	X and Y operation (operation relationship determined by ten's digit)	
		2	Switchover between X and Y	
		3	Switchover between X and "X and Y operation"	
		4	Switchover between Y and "X and Y operation"	
		Ten's digit	X and Y operation relationship	
		0	X + Y	
		1	X – Y	
		2	Maximum	
3	Minimum			

It is used to select the frequency setting channel. If the frequency source involves X and Y operation, you can set the frequency offset in 01.21 for superposition to the X and Y operation result, flexibly satisfying various requirements.

Unit's digit: Frequency source selection

0: Main frequency source X

Main frequency source X as target frequency

1: X and Y operation

Main and auxiliary operation result as the target frequency, main and auxiliary operation relationship see the description of ten digits.

2: Main frequency source X and auxiliary frequency Y switchover

When the multi-function input terminals function 18 (frequency switch) is invalid, the main frequency X as the target frequency.

When the multi-function input terminals function 18 (frequency switch) is valid, the auxiliary frequency Y as the target frequency.

3: The main frequency source X switchover with the main and auxiliary operation result.

When the multi-function input terminals function 18 (frequency switch) is invalid, the main frequency X as the target frequency.

When the multi-function input terminals function 18 (frequency switch) is valid, the main and auxiliary operation result as the target frequency.

4: The auxiliary frequency source Y switchover with the main and auxiliary operation result.

When the multi-function input terminals function 18 (frequency switch) is invalid, the auxiliary frequency Y as the target frequency.

When the multi-function input terminals function 18 (frequency switch) is valid, the main and auxiliary operation result as the target frequency.

Ten digits: Frequency source main and auxiliary operation relations.

0: X+Y

The target frequency is the sum of main frequency X and auxiliary frequency Y.

1: X-Y

The target frequency is the difference between main frequency X and auxiliary frequency Y.

2: MAX

The target frequency is the largest absolute value of main frequency X and auxiliary frequency Y.

3: MIN

The target frequency is the least absolute value of main frequency X and auxiliary frequency Y.

In addition, when the frequency source selection is X and Y, offset frequency can be set by 01.21, offset frequency, superimposed on the advocate complementary operation results in a flexible response to various needs.

01.08	Preset frequency	Default	50.00Hz
	Setting Range	0.00~maximum frequency (valid when frequency source is digital setting)	

If the frequency source is digital setting or terminal UP/DOWN, the value of this parameter is the initial frequency of the AC drive (digital setting)

01.09	Rotation direction	Default	0
	Setting Range	0	Same direction
		1	Reverse direction

You can change the rotation direction of the motor just by modifying this parameter without changing the motor wiring. Modifying this parameter is equivalent to exchanging any two of the motor's U, V, W wires.

Note: The motor will resume running in the original direction after parameter initialization. Do not use this function in applications where changing the rotating direction of the motor is prohibited after system commissioning is complete.

01.10	Maximum frequency	Default	50.00 Hz
	Setting Range	50.00Hz ~ 320.00Hz	

When the frequency source is AI, pulse setting (DI5), or multi-reference, 100% of the input corresponds to the value of this parameter.

The output frequency of the DSI-100 can reach up to 3200 Hz. To take both frequency reference resolution and frequency input range into consideration, you can set the number of decimal places for frequency reference in 01.22.

If 01.22 is set to 1, the frequency reference resolution is 0.1 Hz. In this case, the setting range of 01.10 is 50.0 to 3200.0 Hz.

If 01.22 is set to 2, the frequency reference resolution is 0.01 Hz. In this case, the setting range of 01.10 is 50.00 to 320.00 Hz.

01.11	Source of frequency upper limit	Default	0
	Setting Range	0	Set by 01.12
		1	VS
		2	AS
		3	keyboard potentiometer
		4	PULSE setting (DI5)

It is used to set the source of the frequency upper limit, including digital setting (01.12), AI, pulse setting or communication setting. If the frequency upper limit is set by means of analog input, the analog input setting is 100% corresponding to 01.12.

For example, to avoid runaway in torque control mode in winding application, you can set the frequency upper limit by means of analog input. When the AC drive reaches the upper limit, it will continue to run at this speed.

01.12	Frequency upper limit	Default	50.00Hz
	Setting Range	Frequency lower limit 01.14 ~maximum frequency 01.10	
01.13	Frequency upper limit offset	Default	0.00Hz
	Setting Range	0.00Hz ~maximum frequency 01.10	

If the source of the frequency upper limit is analog input or pulse setting, the final frequency upper limit is obtained by adding the offset in this parameter to the frequency upper limit set in 01.11

01.14	Frequency lower limit	Default	0.00Hz
	Setting Range	0.00Hz ~frequency upper limit 01.12	

If the frequency reference is lower than the value of this parameter, the AC drive can stop, run at the frequency lower limit, or run at zero speed, determined by 08-14.

01.15	Carrier frequency	Default	Model dependent
	Setting Range	0.5kHz ~16.0kHz	

It is used to adjust the carrier frequency of the AC drive, helping to reduce the motor noise, avoiding the resonance of the mechanical system, and reducing the leakage current to the earth and interference generated by the AC drive.

If the carrier frequency is low, output current has high harmonics, and the power loss and temperature rise of the motor increase.

If the carrier frequency is high, power loss and temperature rise of the motor declines.

However, the AC drive has an increase in power loss, temperature rise and interference.

Adjusting the carrier frequency will exert influences on the aspects listed in the following table:

Carrier frequency	Low	-	High
Motor noise	Large	-	Small
Output current waveform	Bad	-	Good
Motor temperature rise	High	-	Low
AC drive temperature rise	Low	-	High
Leakage current	Small	-	Large
External radiation interference	Small	-	Large

The factory setting of carrier frequency varies with the AC drive power. If you need to modify the carrier frequency, note that if the set carrier frequency is higher than factory setting, it will lead to an increase in temperature rise of the AC drive's heatsink. In this case, you need to de-rate the AC drive. Otherwise, the AC drive may overheat and alarm.

01.16	Carrier frequency adjustment with temperature	Default	1
	Setting Range	0: No 1: Yes	

It is used to set whether the carrier frequency is adjusted based on the temperature. The AC drive automatically reduces the carrier frequency when detecting that the heatsink temperature is high. The AC drive resumes the carrier frequency to the set value when the heatsink temperature becomes normal. This function reduces the overheat alarms.

01.17	Acceleration time 1	Default	Model dependent
	Setting Range	0.00s ~ 650.00s (01.19=2) 0.0s ~ 6500.0s (01.19=1) 0s ~ 65000s(01.19=0)	
01.18	Deceleration time 1	Default	Model dependent
	Setting Range	0.00s ~ 650.00s (01.19=2) 0.0s ~ 6500.0s (01.19=1) 0s ~ 65000s(01.19=0)	

Acceleration time indicates the time required by the AC drive to accelerate from 0 Hz to "Acceleration/Deceleration base frequency" (01.25), that is, t1 in below figure

Deceleration time indicates the time required by the AC drive to decelerate from "Acceleration/Deceleration base frequency" (01.25) to 0 Hz, that is, t2 in below figure.

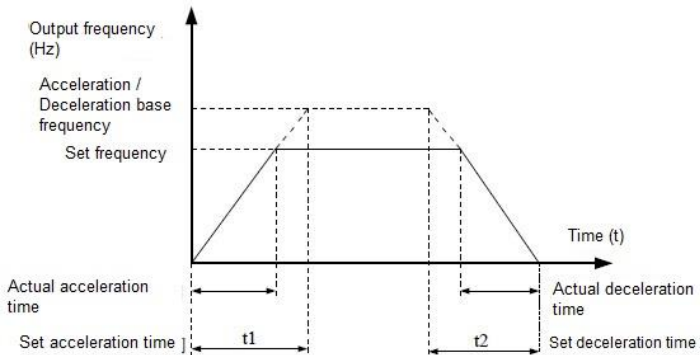

Figure Acceleration / Deceleration time

The DSI-100 provides totally four groups of acceleration/deceleration time for selection. You can perform switchover by using a DI terminal.

Group 1: 01.17, 01.18

Group 2: 09.03, 09.04

Group 3: 09.05, 09.06

Group 4: 09.07, 09.08

01.19	Acceleration/Deceleration time unit		Default	1
	Setting Range	0	1s	
		1	0.1s	
		2	0.01s	

To satisfy requirements of different applications, the DSI-100 provides three acceleration/deceleration time units, 1s, 0.1s and 0.01s.

Note:

Modifying this parameter will make the displayed decimal places change and corresponding acceleration/deceleration time also change.

01.21	Frequency offset of auxiliary frequency source for X and Y operation	Default	0.00Hz
	Setting Range	0.00Hz ~maximum frequency 01.10	

This function code is only valid when the frequency source is selected as main and auxiliary operation.

When the frequency source is the main and auxiliary operation, 01.21 is used as the offset frequency, which is superimposed with the main and auxiliary operation results as the final frequency setting value, so that the frequency setting can be more flexible.

01.22	Frequency reference resolution		Default	2
	Setting Range	1	0.1Hz	
		2	0.01Hz	

This parameter is used to determine the resolution of all frequency-related function codes.

When the frequency resolution is 0.1Hz, the maximum output frequency of DSI-100 can reach 3200Hz, and when the frequency resolution is 0.01Hz, the maximum output frequency of DSI-100 is 600.00Hz

Note: When modifying this function parameter, the decimal places of all frequency-related parameters will change, and the corresponding frequency value will also change. Special attention should be paid during use;

01.23	Retentive of digital setting frequency upon power failure		Default	0
	Setting Range	0	Not retentive	
		1	Retentive	

This parameter is valid only when the frequency source is digital setting.

If 01.23 is set to 0, the digital setting frequency value resumes to the value of 01.08 (Preset frequency) after the AC drive stops. The modification by using keys ▲ and ▼ or the terminal UP/DOWN function is cleared.

If 01.23 is set to 1, the digital setting frequency value is the set frequency at the moment when the AC drives stops. The modification by using keys ▲ and ▼ or the terminal UP/DOWN function remains effective.

01.24	Motor parameter group selection		Default	0
	Setting Range	0	Motor parameter group 1	
		1	Reserved	
		2	Reserved	
		3	Reserved	
01.25	Acceleration/Deceleration time base frequency		Default	0
	Setting Range	0	Maximum (01.10)	
		1	Set frequency	
		2	100Hz	

The acceleration and deceleration time refers to the acceleration and deceleration time from zero frequency to the frequency set by 01.25. When 01.25 is selected as 1, the acceleration and deceleration time is related to the set frequency. If the set frequency changes frequently, the acceleration of the motor changes, so attention should be paid to the application.

01.26	Base frequency for UP/DOWN modification during running		Default	0
	Setting Range	0	Running frequency	
		1	Set frequency	

This parameter is valid only when the frequency source is digital setting.

It is used to set the base frequency to be modified by using keys ▲ and ▼ or the terminal UP/DOWN function. If the running frequency and set frequency are different, there will be a large difference between the AC drive's performance during the acceleration/deceleration process.

01.27	Binding command source to frequency source		Default	000
	Setting Range	Unit's digit	Binding operation panel command to frequency source	
		0	No binding	
		1	Frequency source by digital setting	
		2	AI1	
		3	AI2	
		4	Reserved	
		5	PULSE setting (X5)	
		6	Multi-reference	
		7	Simple PLC	
		8	PID	
		9	Communication setting	
		Ten's digit	Binding terminal command to frequency source (0-9, same as unit's digit)	
	Hundred's digit	Binding communication command to frequency source (0-9, same as unit's digit)		

Define the binding combination between three running command channels and nine frequency given channels to facilitate synchronous switching.

The meaning of the above frequency given channel is the same as the main frequency source X selection 01.03, please refer to the description of 01.03 function code.

Different running command channels can be bundled with the same frequency given channel.

When the command source has a bundled frequency source, the frequency source set by 01.03~01.07 will no longer work during the valid period of the command source.

01.28	Serial communication protocol		Default	0
	Setting Range	0	MODBUS protocol	
		1	Reserved	
		2	Reserved	

Group 02: Motor 1 Parameters

02.00	Motor type selection		Default	0
	Setting Range	0	Common asynchronous motor	
		1	Variable frequency asynchronous motor	
		2	Reserved	
02.01	Rated motor power		Default	Model dependent
	Setting Range		0.1kW ~ 1000.0kW	
02.02	Rated motor voltage		Default	Model dependent
	Setting Range		1V ~ 2000V	

02.03	Rated motor current	Default	Model dependent
	Setting Range	0.01A ~655.35A(AC drive power <=55kW) 0.1A ~6553.5A(AC drive power >55kW)	
02.04	Rated motor frequency	Default	Model dependent
	Setting Range	0.01Hz ~maximum frequency	
02.05	Rated motor rotational speed	Default	Model dependent
	Setting Range	1rpm ~65535rpm	

Set the parameters according to the motor nameplate, no matter whether V/F control or vector control is adopted.

To achieve better V/F or vector control performance, motor auto-tuning is required. The motor auto-tuning accuracy depends on the correct setting of motor nameplate parameters.

02.06	Stator resistance (asynchronous motor)	Default	Model dependent
	Setting Range	0.001Ω ~65.535Ω(AC drive power ≤ 55kW) 0.0001Ω ~6.5535Ω(AC drive power >55kW)	
02.07	Rotor resistance (asynchronous motor)	Default	Model dependent
	Setting Range	0.001Ω ~65.535Ω(AC drive power ≤ 55kW) 0.0001Ω ~6.5535Ω(AC drive power >55kW)	
02.08	Leakage inductive reactance (asynchronous motor)	Default	Model dependent
	Setting Range	0.01mH ~655.35mH(AC drive power ≤ 55kW) 0.001mH ~65.535mH(AC drive power >55kW)	
02.09	Mutual inductive reactance	Default	Model dependent
	Setting Range	0.1mH ~6553.5mH(AC drive power ≤ 55kW) 0.01mH ~655.35mH(AC drive power >55kW)	
02.10	No-load current (asynchronous motor)	Default	Model dependent
	Setting Range	0.01A ~02-03(AC drive power ≤ 55kW) 0.1A ~02-03(AC drive power >55kW)	

02.06~02.10 are the parameters of the asynchronous motor, these parameters are generally not on the motor nameplate, and need to be obtained through the automatic tuning of the inverter.

Among them, "asynchronous motor static tuning" can only obtain three parameters of 02.06~02.08, and "asynchronous motor complete tuning" can obtain all the five parameters here, as well as current loop PI parameters and so on.

When changing the rated power of the motor (02.01) or the rated voltage of the motor (02.02), the inverter will automatically modify the parameter values of 02.06 to 02.10, and restore these 5 parameters to the commonly used standard Y series motor parameters.

If it is not possible to tune the asynchronous motor on site, you can enter the above corresponding function code according to the parameters provided by the motor manufacturer.

02.37	Auto-tuning selection	Default	0
	Setting	0	No auto-tuning
		1	Asynchronous motor static auto-tuning
		2	Asynchronous motor complete auto-tuning
		3	Static complete parameter identification

In order to ensure the best control performance of the inverter during vector control, please disconnect the load from the motor and use rotary tuning to perform motor parameter self-learning, otherwise the vector control effect will be affected. When the motor with a large inertia load is not easy to disengage and vector control is required, please use the static complete parameter identification.

Before parameter self-learning, it is necessary to correctly set the motor type and nameplate parameters 02.00~02.05.

Tuning action description: Set the motor nameplate parameters and self-learning type, and then press the RUN key, the inverter will perform static tuning.

0: No operation, that is, tuning is prohibited.

1: Asynchronous motor static tuning 1, which is suitable for the occasions where the asynchronous motor and the large inertia load are not easy to be disengaged, and the rotation tuning cannot be performed.

2: Asynchronous motor dynamic tuning

During the dynamic tuning process, the inverter first performs static tuning, and then accelerates to 80% of the rated frequency of the motor according to the acceleration time 01.17. After maintaining for a period of time, it decelerates to stop according to the deceleration time 01.18 and ends the tuning.

3: Static complete parameter identification

It is suitable for the case of no encoder, self-learning of motor parameters when the motor is stationary (the motor may still vibrate slightly at this time, please pay attention to safety)

Action description: Set the function code to 3, then press the RUN key, the inverter will perform no-load tuning

Note: Tuning supports motor tuning in keyboard operation mode, terminal mode, and communication mode.

Group 03 Vector Control Parameters

This group of function codes is only valid for vector control and invalid for VF control.

03.00	Speed loop proportional gain 1	Default	30
	Setting Range	1 ~ 100	
03.01	Speed loop integral time 1	Default	0.50s
	Setting Range	0.01s ~ 10.00s	
03.02	Switchover frequency 1	Default	5.00Hz
	Setting Range	0.00 ~ 03.05	
03.03	Speed loop proportional gain 2	Default	20
	Setting Range	0 ~ 100	
03.04	Speed loop integral time 2	Default	1.00s
	Setting Range	0.01s ~ 10.00s	
03.05	Switchover frequency 2	Default	10.00Hz
	Setting Range	03.02 ~ maximum output frequency	

When the inverter runs at different frequencies, different speed loop PI parameters can be selected. When the running frequency is less than the switching frequency 1 (03.02), the speed loop PI adjustment parameters are 03.00 and 03.01. When the running frequency is greater than the switching frequency 2, the speed loop PI adjustment parameters are 03.03 and 04.04. The speed loop PI parameters between switching frequency 1 and switching frequency 2 are linearly switched between two sets of PI parameters, as shown in Figure below

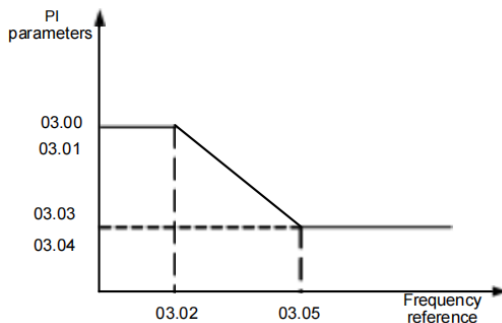

Schematic diagram of PI parameters

The speed dynamic response characteristics in vector control can be adjusted by setting the proportional gain and integral time of the speed regulator.

To achieve a faster system response, increase the proportional gain and reduce the integral time. Be aware that this may lead to system oscillation.

The recommended adjustment method is as follows:

If the factory setting cannot meet the requirements, make proper adjustment. Increase the proportional gain first to ensure that the system does not oscillate, and then reduce the integral time to ensure that the system has quick response and small overshoot.

Note: Improper PI parameter setting may cause too large speed overshoot, and over voltage fault may even occur when the overshoot drops.

03.06	Vector control slip	Default	100%
	Setting Range	50% ~200%	

For SVC, it is used to adjust speed stability accuracy of the motor. When the motor with load runs at a very low speed, increase the value of this parameter; when the motor with load runs at a very large speed, decrease the value of this parameter.

For FVC, it is used to adjust the output current of the AC drive with same load.

03.07	Time constant of speed loop filter	Default	0.000s
	Setting Range	0.000s ~0.100s	

In the vector control mode, the output of the speed loop regulator is torque current reference. This parameter is used to filter the torque references. It need not be adjusted generally and can be increased in the case of large speed fluctuation. In the case of motor oscillation, decrease the value of this parameter properly.

If the value of this parameter is small, the output torque of the AC drive may fluctuate greatly, but the response is quick.

03.08	Vector control over-excitation gain	Default	64
	Setting Range	0 ~200	

During the deceleration process of the inverter, the over-excitation control can suppress the rise of the bus voltage and avoid over-voltage faults. The larger the over-excitation gain, the stronger the suppression effect.

For occasions where the inverter is prone to over-voltage alarm during deceleration, it is necessary to increase the over-excitation gain. However, if the over-excitation gain is too large, it will easily lead to an increase in the output current, which needs to be weighed in the application.

In the case of small inertia, the voltage will not rise during motor deceleration, it is recommended to set the over-excitation gain to 0; in the case of a braking resistor, it is also recommended to set the over-excitation gain to 0.

03.09	Torque upper limit source in speed control mode		Default	0
	Setting Range	0	03.10	
		1	AI1	
		2	AI2	
		3	AI3 (keyboard potentiometer)	
		4	PULSE setting (DI5)	
5	Communication setting			

03.10	Digital setting of torque upper limit in speed control mode	Default	150.0%
	Setting Range	0.0% ~200.0%	

In the speed control mode, the maximum output torque of the AC drive is restricted by 03.09.

If the torque upper limit is analog, pulse or communication setting, 100% of the setting corresponds to the value of 03.10, and 100% of the value of 03.10 corresponds to the AC drive rated torque.

03.13	Excitation adjustment proportional gain	Default	2000
	Setting Range	0 ~ 20000	
03.14	Excitation adjustment integral gain	Default	1300
	Setting Range	0 ~ 20000	
03.15	Torque adjustment proportional	Default	2000
	Setting Range	0 ~ 20000	
03.16	Torque adjustment integral gain	Default	1300
	Setting Range	0 ~ 20000	

These are current loop PI parameters for vector control. These parameters are automatically obtained through "Asynchronous motor complete auto-tuning" or "Synchronous motor no-load auto-tuning", and do not need to be modified.

The dimension of the current loop integral regulator is integral gain rather than integral time.

Note that too large current loop PI gain may lead to oscillation of the entire control loop.

Therefore, when current oscillation or torque fluctuation is great, manually decrease the proportional gain or integral gain here.

Group 04 V/F Control Parameters

This group of function codes is only valid for V/F control and invalid for vector control.

V/F control is suitable for general-purpose loads such as fans and pumps, or one inverter with multiple motors, or applications where the power of the inverter and the motor are quite different.

04.00	V/F curve setting	Default	0
	Setting Range	0	Linear VF
		1	Multi-point VF
		2	Square VF
		3	1.2-power VF
		4	1.4-power VF
		6	1.6-power VF
		8	1.8-power VF
		9	Reserved
		10	VF complete separation
11	VF half separation		

0: Linear V/F. It is applicable to common constant torque load.

1: Multi-point VF. It is applicable to special load such as dehydrator and centrifuge. Any such VF curve can be obtained by setting parameters of 04.03~04.08.

2: Square VF. It is applicable to centrifugal loads such as fan and pump.

3~8: VF curve between linear VF and square VF

10: VF complete separation. In this mode, the output frequency and output voltage of the AC drive are independent. The output frequency is determined by the frequency source, and the output voltage is determined by "Voltage source for VF separation" (04.13).

It is applicable to induction heating, inverse power supply and torque motor control.

11: VF half separation

In this mode, V and F are proportional and the proportional relationship can be set in 04.13. The relationship between V and F are also related to the rated motor voltage and rated motor frequency in Group 02.

Assume that the voltage source input is X (0 to 100%), the relationship between V and F is:

$$V/F = 2 * X * (\text{Rated motor voltage}) / (\text{Rated motor frequency})$$

04.01	Torque boost	Default	Model dependent
	Setting Range	0.0% ~30%	
04.02	Cut-off frequency of torque boost	Default	50.00Hz
	Setting Range	0.00Hz ~maximum output frequency	

To compensate the low frequency torque characteristics of V/F control, you can boost the output voltage of the AC drive at low frequency by modifying 04.01. If the torque boost is set to too large, the motor may overheat, and the AC drive may suffer over current.

If the load is large and the motor startup torque is insufficient, increase the value of 04.01.

If the load is small, decrease the value of 04.01. If it is set to 0.0, the AC drive performs automatic torque boost. In this case, the AC drive automatically calculates the torque boost value based on motor parameters including the stator resistance.

04.02 specifies the frequency under which torque boost is valid. Torque boost becomes invalid when this frequency is exceeded, as shown in the following figure.

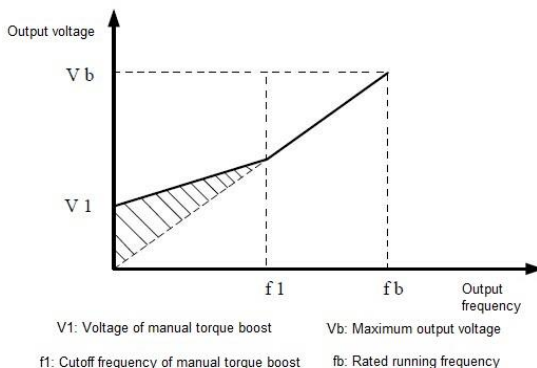

Figure Manual torque boost

04.03	Multi-point VF frequency P1	Default	0.00Hz
	Setting Range	0.00Hz ~04.05	
04.04	Multi-point VF voltage V1	Default	0.0%
	Setting Range	0.0% ~100.0%	
04.05	Multi-point VF frequency P2	Default	0.00Hz
	Setting Range	04.03 ~04.07	
04.06	Multi-point VF voltage V2	Default	0.0%
	Setting Range	0.0% ~100.0%	

04.07	Multi-point VF frequency P3	Default	0.00Hz
	Setting Range	04.05~rated motor frequency (02-04)	
04.08	Multi-point VF voltage V3	Default	0.0%
	Setting Range	0.0% ~ 100.0%	

These six parameters 04.03~04.08 are used to define the multi-point VF curve.

The multi-point VF curve is set based on the motor's load characteristic. The relationship between voltages and frequencies is:

$$V1 < V2 < V3, P1 < P2 < P3$$

At low frequency, higher voltage may cause overheat or even burnt out of the motor and over current stall or over current protection of the AC drive.

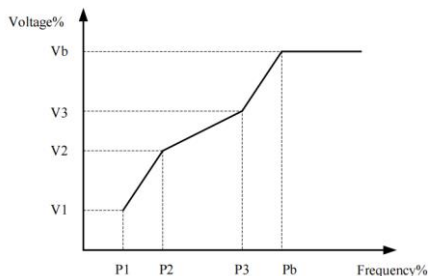

V1-V3: The percentage of the voltage of the 1st-3rd stage of the multi-points V/F

P1-P3: The percentage of the current of the 1st-3rd stage of the multi-points V/F

Vb: Motor rated voltage Fb: Motor rated frequency

Figure Setting of multi-point VF curve

04.09	VF slip compensation	Default	0.0%
	Setting Range	0% ~ 200.0%	

This parameter is valid only for the asynchronous motor.

It can compensate the rotational speed slip of the asynchronous motor when the load of the motor increases, stabilizing the motor speed in case of load change.

If this parameter is set to 100%, it indicates that the compensation when the motor bears rated load is the rated motor slip. The rated motor slip is automatically obtained by the AC drive through calculation based on the rated motor frequency and rated motor rotational speed in group 02.

Generally, if the motor rotational speed is different from the target speed, slightly adjust this parameter.

04.10	VF over-excitation gain	Default	64
	Setting	0 ~ 200	

During deceleration of the AC drive, over-excitation can restrain rise of the bus voltage, preventing the over voltage fault. The larger the over-excitation is, the better the restraining result is.

Increase the over-excitation gain if the AC drive is liable to over voltage error during deceleration.

However, too large over-excitation gain may lead to an increase in the output current.

Set 04.09 to a proper value in actual applications.

Set the over-excitation gain to 0 in the applications where the inertia is small and the bus voltage will not rise during motor deceleration or where there is a braking resistor.

04.11	VF oscillation suppression gain	Default	Model dependent
	Setting Range	0 ~ 100	

Set this parameter to a value as small as possible in the prerequisite of efficient oscillation suppression to avoid influence on VF control.

Set this parameter to 0 if the motor has no oscillation. Increase the value properly only when the motor has obvious oscillation. The larger the value is, the better the oscillation suppression result will be.

When the oscillation suppression function is enabled, the rated motor current and no-load current must be correct. Otherwise, the VF oscillation suppression effect will not be satisfactory.

04.13	VF Voltage source for VF	Def	0
	Setting Range	0	Digital setting (P3-14)
		1	AI1
		2	AI2
		3	AI3 (keyboard potentiometer)
		4	PULSE setting (DI5)
		5	Multi-reference
		6	Simple PLC
		7	PID
		8	Communication setting
100.0% corresponds to the rated motor voltage 02.02			

VF separation is generally applicable to scenarios such as induction heating, inverse power supply and motor torque control.

If VF separated control is enabled, the output voltage can be set in 04.14 or by means of analog, multi-reference, simple PLC, PID or communication. If you set the output voltage by means of non-digital setting, 100% of the setting corresponds to the rated motor voltage. If a negative percentage is set, its absolute value is used as the effective value.

0: Digital setting (04.14)

The output voltage is set directly in 04.14.

1: AI1 2: AI2 3: AI3 (keyboard potentiometer)

The output voltage is set by AI terminals.

4: PULSE setting (DI5)

The output voltage is set by pulses of the terminal DI5.

Pulse setting specification: voltage range 9–30 V, frequency range 0–100 kHz

5: Multi-reference

If the voltage source is multi-reference, parameters in group 04 and 13 must be set to determine the corresponding relationship between setting signal and setting voltage.

6: Simple PLC

If the voltage source is simple PLC mode, parameters in group 13 must be set to determine the setting output voltage.

7: PID

The output voltage is generated based on PID closed loop. For details, see the description of PID in group 11.

8: Communication setting

The output voltage is set by the host computer by means of communication.

When the voltage source to choose 1 ~ 8, 0 ~ 100% are corresponding to the output voltage of 0 V ~ motor rated voltage.

04.14	VF Separation of digital voltage setting	Default	0V
-------	--	---------	----

	Setting Range	0V ~Motor Rated Voltage	
04.15	Voltage rise time of VF separation	Default	0.0s
	Setting Range	0.0s ~1000.0s	
04.16	Voltage decline time of VF separation	Default	0.0s
	Setting Range	0.0s ~1000.0s	

The voltage source for VF separation is set in the same way as the frequency source. For details, see 01.03. 100.0% of the setting in each mode corresponds to the rated motor voltage. If the corresponding value is negative, its absolute value is used

04.15 indicates the time required for the output voltage to rise from 0 V to the rated motor voltage shown as t1 in the following figure.

04.16 indicates the time required for the output voltage to decline from the rated motor voltage to 0 V, shown as t2 in the following figure.

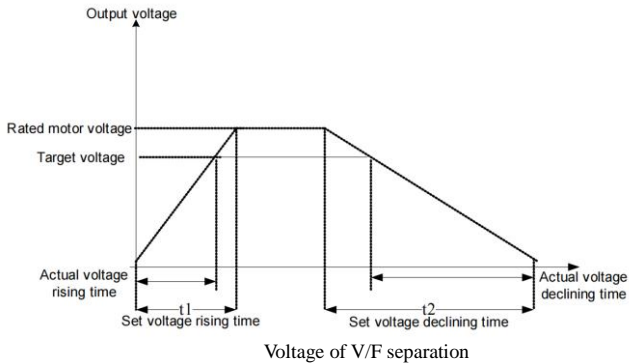

04.17	VF separation stop mode selection	Default	0s
	Setting Range	0: Frequency/voltage is reduced to 0 independently 1: After the voltage is reduced to 0, the frequency is reduced again	

0: Frequency/voltage is reduced to 0 independently

The output voltage of V/F separation is decreased to 0V according to the voltage drop time (04.15); the frequency is decreased to 0Hz according to the deceleration time (01.18) at the same time.

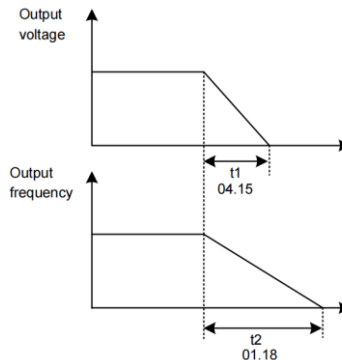

1: After the voltage is reduced to 0, the frequency is reduced

The output voltage of V/F separation is first decreased to 0V according to the voltage drop time (04.15), and then the frequency is decreased to 0Hz according to the deceleration time (01.18).

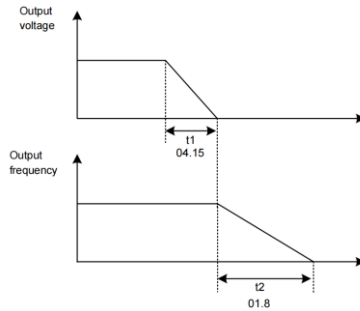
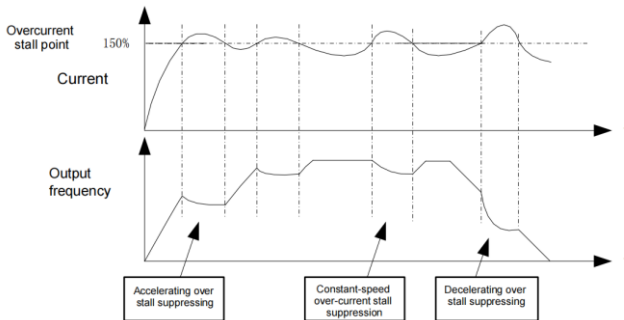

Figure Schematic diagram of successive drops of V/F separation frequency/voltage

• Inverter output current (torque) limit

During acceleration, constant speed and deceleration, if the current exceeds the overcurrent stall current point (150%), the overcurrent stall will take effect. When the current exceeds the overcurrent stall, the output frequency will begin to decrease until the current returns to the overcurrent stall. After the point is below, the frequency will start to accelerate up to the target frequency, and the actual acceleration time will be automatically extended. If the actual acceleration time cannot meet the requirements, "02.21 Overcurrent stall action current" can be appropriately increased.



Schematic diagram of overcurrent stall action

Function Code	Function	Setting Range	Function description
04.18	Overcurrent stall action current	150%	Over-current stall suppression
04.19	Over-current stall suppression	1	0 invalid, 1 valid
04.20	Overcurrent Stall Suppression Gain	20	If the current exceeds the overcurrent stall current point,
04.21	Double-speed overcurrent stall action current compensation	50%	Reduce the high-speed overcurrent stall action

In the high frequency region, the motor drive current is small. Compared with the same stall current below the rated frequency, the speed of the motor drops greatly. In order to improve the operating characteristics of the motor, the stall action current above the rated frequency can be reduced. In some centrifuges when the operating frequency is high, several times of field weakening is required and the load inertia is large, this method has a good effect on the acceleration performance.

$$\text{Transient stall action current over rated frequency} = (f_s/f_n) * k * \text{LimitCur};$$

f_s is the running frequency, f_n is the rated frequency of the motor, k is the 04.21 "double-speed overcurrent stall action current compensation coefficient", and LimitCur is 04.18 "overcurrent stall action current";

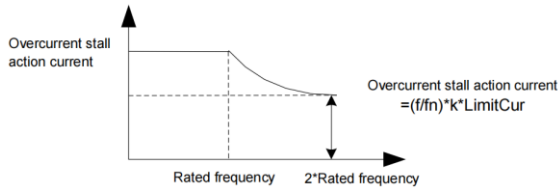

Schematic diagram of double-speed over-speed stall action

Remark:

Over-current stall action current of 150% means 1.5 times the rated current of the inverter;

For high-power motors, the carrier frequency is below 2kHz. Due to the increase of the pulsating current, the wave-by-wave current limiting response starts before the overcurrent stall prevention action, resulting in insufficient torque. In this case, please reduce the overcurrent stall prevention action current.

- Inverter bus voltage limit (and braking resistor turn-on voltage setting)

If the bus voltage exceeds the overvoltage stall point of 760V, it means that the electromechanical system is in the power generation state (motor speed > output frequency), the overvoltage stall will take effect, adjust the output frequency (consume more electricity than the feedback), and the actual deceleration time will be automatically Lengthen to avoid tripping protection. If the actual deceleration time cannot meet the requirements, the over-excitation gain can be appropriately increased.

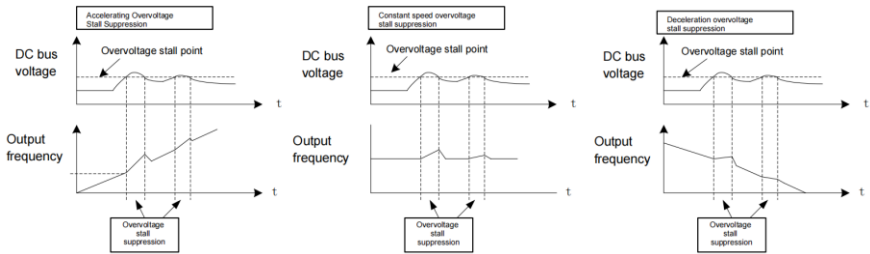

Schematic diagram of overvoltage stall action

Function Code	Function	Setting Range	Function description
04.22	Overvoltage stall action voltage	760V	
04.23	Over-voltage stall suppression enable	1	0 invalid, 1 valid
04.24	Overvoltage stall suppression frequency gain	30	
04.25	Overvoltage Stall Suppression Voltage Gain	30	Increasing 04.24 will improve the control effect of bus voltage. However, the output frequency will fluctuate. If the output frequency fluctuates greatly, 04.24 can be appropriately reduced. Increasing 04.2 can reduce the overshoot of bus voltage 04.25.
04.26	Overvoltage stall maximum rising frequency limit	5Hz	Overvoltage stall maximum rising frequency limit

Remark:

When using a braking resistor or adding a braking unit or using an energy regenerative unit, please pay attention:

Please set the value of 04.11 "over excitation gain" to "0", if it is not "0", it may cause the problem of excessive current during operation.

Please set the value of 04.23 "overvoltage stall enable" to "0", if it is not "0", it may cause the problem of prolonged deceleration time.

Group 05 Input Terminals

DSI-100 series inverters are equipped with 5 multi-function digital input terminals as standard (DI5 can be used as high-speed pulse input terminal) and 2 analog input terminals.

Function Code	Parameter Name	Default	Remark
05.00	DI1 function selection	1 (FWD)	Standard
05.01	DI2 function selection	2 (REV)	Standard
05.02	DI3 function selection	9 (Alarm reset)	Standard
05.03	DI4 function selection	12: Multi-reference terminal 1	Standard
05.04	DI5 function selection	13: Multi-reference terminal 2	Standard

The following table lists the functions available for the DI terminals.

Value	Function	Description
0	No function	Set 0 for reserved terminals to avoid malfunction.
1	Forward RUN (FWD)	The terminal is used to control forward or reverse RUN of the AC drive.
2	Reverse RUN (REV)	
3	Three-line control	The terminal determines three-line control of the AC drive. For details, see the description of 05.11.
4	Forward JOG (FJOG)	FJOG indicates forward JOG running, while RJOG indicates reverse JOG running. The JOG frequency, acceleration time and deceleration time are described respectively in 10.00, 10.01 and 10.02.
5	Reverse JOG (RJOG)	
6	Terminal UP	If the frequency is determined by external terminals, the terminals with the two functions are used as increment and decrement commands for frequency modification. When the frequency source is digital setting, they are used to adjust the frequency.
7	Terminal DOWN	
8	Coast to stop	The AC drive blocks its output, the motor coasts to rest and is not controlled by the AC drive. It is the same as coast to stop described in 07.10.
9	Fault reset (RESET)	The terminal is used for fault reset function, the same as the function of RESET key on the operation panel. Remote fault reset is implemented by this function.
10	RUN pause	The AC drive decelerates to stop, but the running parameters are all memorized, such as PLC, swing frequency and PID parameters. After this function is disabled, the AC drive resumes its status before stop.
11	Normally open (NO) input of external fault	If this terminal becomes ON, the AC drive reports Err15 and performs the fault protection action. For more details, see the description of 10.47.

12	Multi-reference terminal K1	The setting of 16 speeds or 16 other references can be implemented through combinations of 16 states of these four terminals. For more details, see appendix 1.
13	Multi-reference terminal K2	
14	Multi-reference terminal K3	
15	Multi-reference terminal K4	
16	Terminal 1 for ACC/DEC time selection	Totally four groups of acceleration/deceleration time can be selected through combinations of two states of these two terminals. For more details, see appendix 2.
17	Terminal 2 for ACC/DEC time selection	
18	Frequency source switchover	The terminal is used to perform switchover between two frequency sources according to the setting in 01.07.
19	UP/DOWN setting clear (terminal, operation panel)	If the frequency source is digital setting, the terminal is used to clear the modification by using the UP/DOWN function or the increment/decrement key on the operation panel, returning the set frequency to the value of 01.08.
20	Command source switchover terminal	If the command source is set to terminal control (01.02 = 1), this terminal is used to perform switchover between terminal control and operation panel control. If the command source is set to communication control (01.02 = 2), this terminal is used to perform switchover between communication control and operation panel control.
21	ACC/DEC prohibited	It enables the AC drive to maintain the current frequency output without being affected by external signals (except the STOP command).
22	PID pause	PID is invalid temporarily. The AC drive maintains the current frequency output without supporting PID adjustment of frequency source.
23	PLC status reset	The terminal is used to restore the original status of PLC control for the AC drive when PLC control is started again after a pause.
24	Swing pause	The AC drive outputs the central frequency, and the swing frequency function pauses.
25	Counter input	This terminal is used to count pulses.
26	Counter reset	This terminal is used to clear the counter status.
27	Length count input	This terminal is used to count the length.
28	Length reset	This terminal is used to clear the length.
29	Torque control prohibited	The AC drive is prohibited from torque control and enters the speed control mode.
30	Pulse input (enabled only for DI5)	DI5 is used for pulse input.
31	Reserved	Reserved
32	Immediate DC braking	After this terminal becomes ON, the AC drive directly switches over to the DC braking state.
33	Normally closed (NC) input of external fault	After this terminal becomes ON, the AC drive reports Err15 and stops.
34	Frequency modification forbidden	After this terminal becomes ON, the AC drive does not respond to any frequency modification.

35	Reverse PID action direction	After this terminal becomes ON, the PID action direction is reversed to the direction set in 11-03.
36	External STOP terminal 1	In operation panel mode, this terminal can be used to stop the AC drive, equivalent to the function of the STOP key on the operation panel.
37	Command source switchover terminal 2	It is used to perform switchover between terminal control and communication control. If the command source is terminal control, the system will switch over to communication control after this terminal becomes ON.
38	PID integral pause	After this terminal becomes ON, the integral adjustment function pauses. However, the proportional and differentiation adjustment functions are still valid.
39	Switchover between main frequency source X and preset frequency	After this terminal becomes ON, the frequency source X is replaced by the preset frequency set in 11-08.
40	Switchover between auxiliary frequency source Y and preset frequency	After this terminal is enabled, the frequency source Y is replaced by the preset frequency set in 01.08.
41	Reserved	Reserved
42	Reserved	
43	PID parameter switchover	If the PID parameters switchover performed by means of DI terminal (11.18 = 1), the PID parameters are 11.05 to 11.07 when the terminal becomes OFF; the PID parameters are 11.15 to 11.17 when this terminal becomes ON.
44	User-defined fault 1	If these two terminals become ON, the AC drive reports Err27 and Err28 respectively, and performs fault protection actions based on the setting in 10.49.
45	User-defined fault 2	
46	Reserved	Reserved
47	Emergency stop	When this terminal becomes ON, the AC drive stops within the shortest time. During the stop process, the current remains at the set current upper limit. This function is used to satisfy the requirement of stopping the AC drive in emergency state.
48	External STOP terminal 2	In any control mode (operation panel, terminal or communication), it can be used to make the AC drive
49	Deceleration DC braking	When this terminal becomes ON, the AC drive decelerates to the initial frequency of stop DC braking and then switches over to DC braking state.
50	Clear the current running time	When this terminal becomes ON, the AC drive's current running time is cleared. This function must be supported by 09.42 and 09.53.

Appendix 1: State combinations of the four multi-reference terminals

The four multi-reference terminals have 16 state combinations, corresponding to 16 reference values, as listed in the following table:

K4	K3	K2	K1	Reference Setting	Corresponding Parameter
OFF	OFF	OFF	OFF	Reference 0	13.00
OFF	OFF	OFF	ON	Reference 1	13.01
OFF	OFF	ON	OFF	Reference 2	13.02
OFF	OFF	ON	ON	Reference 3	13.03
OFF	ON	OFF	OFF	Reference 4	13.04
OFF	ON	OFF	ON	Reference 5	13.05
OFF	ON	ON	OFF	Reference 6	13.06
OFF	ON	ON	ON	Reference 7	13.07
ON	OFF	OFF	OFF	Reference 8	13.08
ON	OFF	OFF	ON	Reference 9	13.09
ON	OFF	ON	OFF	Reference 10	13.10
ON	OFF	ON	ON	Reference 11	13.11
ON	ON	OFF	OFF	Reference 12	13.12
ON	ON	OFF	ON	Reference 13	13.13
ON	ON	ON	OFF	Reference 14	13.14
ON	ON	ON	ON	Reference 15	13.15

If the frequency source is multi-reference, the value 100% of 13.00~13.15 corresponds to the value of 01.10 (Maximum frequency).

Besides the multi-speed function, the multi-reference can be also used as the PID setting source or the voltage source for VF separation, satisfying the requirement on switchover of different setting values.

Appendix 2: State combinations of two terminals for acceleration/deceleration time selection

K2	K1	Acceleration/Deceleration Time Selection	Corresponding Parameters
OFF	OFF	Acceleration/Deceleration time 1	01.17, 01.18
OFF	ON	Acceleration/Deceleration time 2	09.03, 09.04
ON	OFF	Acceleration/Deceleration time 3	09.05, 09.06
ON	ON	Acceleration/Deceleration time 4	09.07, 09.08

05.10	DI filter time	Default	0.010s
	Setting Range	0.000s ~ 1.000s	

It is used to set the software filter time of DI terminal status. If DI terminals are liable to interference and may cause malfunction, increase the value of this parameter to enhance the anti-interference capability. However, increase of DI filter time will reduce the response of DI terminals.

05.11	Terminal command mode		Default	0
	Setting Range	0	Two-line mode 1	
		1	Two-line mode 2	
		2	Three-line mode 1	
		3	Three-line mode 2	

This parameter is used to set the mode in which the AC drive is controlled by external terminals.

0: Two-line mode 1:

It is the most commonly used two-line mode, in which the forward/reverse rotation of the motor is decided by

X1 and X2. The parameters are set as below:

Function Code	Parameter Name	Value	Function Description
05.11	Terminal command mode	0	Two-line 1
05.00	X1 function selection	1	Forward RUN (FWD)
05.01	X2 function selection	2	Reverse RUN (REV)

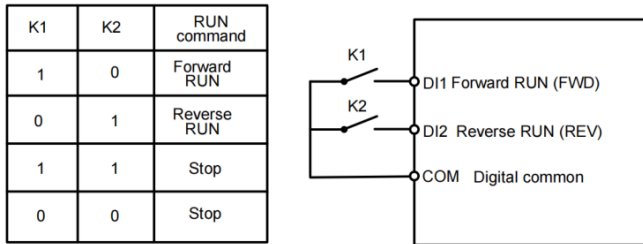

Figure Setting of two-line mode 1

1: Two-line mode 2

In this mode, X1 is RUN enabled terminal, and X2 determines the running direction.

The parameters are set as below:

Function Code	Parameter Name	Value	Function Description
05.11	Terminal command mode	1	Two-line 2
05.00	X1 function selection	1	RUN enabled
05.01	X2 function selection	2	Forward or reverse direction

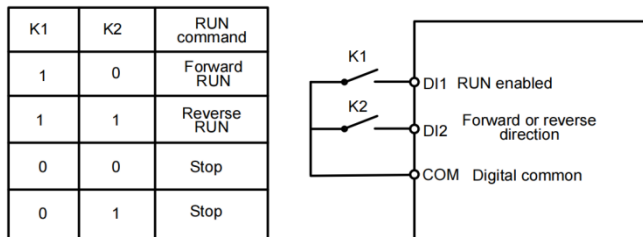

Figure Setting of two-line mode 2

As shown in the preceding figure, if K1 is ON, the AC drive instructs forward rotation when K2 is OFF, and instructs reverse rotation when K2 is ON. If K1 is OFF, the AC drive stops.

2: Three-line mode 1

In this mode, X3 is RUN enabled terminal, and the direction is decided by X1 and X2.

The parameters are set as below:

Function Code	Parameter Name	Value	Function Description
05.11	Terminal command mode	2	Three-line 1

05.00	X1 function selection	1	Forward RUN (FWD)
05.01	X2 function selection	2	Reverse RUN (REV)
05.02	X3 function selection	3	Three-line control

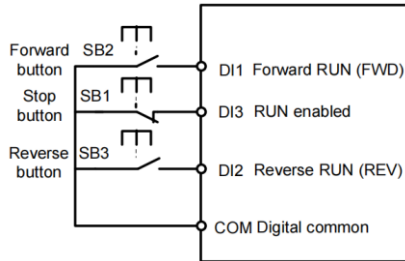

Setting of three-line mode 1

As shown in the preceding figure, if SB1 is ON, the AC drive instructs forward rotation when SB2 is pressed to be ON and instructs reverse rotation when SB3 is pressed to be ON. The AC drive stops immediately after SB1 becomes OFF. During normal startup and running, SB1 must remain ON. The AC drive's running state is determined by the final actions on SB1, SB2 and SB3.

3: Three-line mode 2

In this mode, X3 is RUN enabled terminal. The RUN command is given by X1 and the direction is decided by X2. The parameters are set as below:

Function Codes are set as below:

Function Code	Parameter Name	Value	Function Description
05.11	Terminal command mode	3	Three-line 2
05.00	X1 function selection	1	RUN enabled
05.01	X2 function selection	2	Forward or reverse direction
05.02	X3 function selection	3	Three-line control

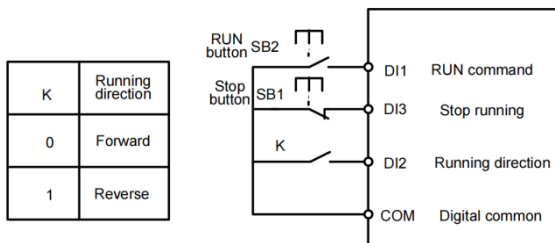

Setting of three-line mode 2

As shown in the preceding figure, if SB1 is ON, the AC drive starts running when SB2 is pressed to be ON; the AC drive instructs forward rotation when K is OFF and instructs reverse rotation when K is ON. The AC drive stops immediately after SB1 becomes OFF. During normal startup and running, SB1 must remain ON. The AC drive's running state is determined by the final actions of SB1, SB2 and K.

05.12	Terminal UP/DOWN rate	Default	1.00Hz/s
	Setting Range	0.01Hz/s ~ 65.535Hz/s	

It is used to adjust the rate of change of frequency when the frequency is adjusted by means of terminal UP/DOWN.

If 01.22 (Frequency reference resolution) is 2, the setting range is 0.001–65.535 Hz/s.

If 01.22 (Frequency reference resolution) is 1, the setting range is 0.01–655.35 Hz/s.

05.13	AI1 curve 1 minimum input	Default	0.00V
	Setting Range	0.00V ~ 05.15	
05.14	Corresponding setting of AI1 curve 1 minimum input	Default	0.0%
	Setting Range	-100.00% ~ 100.0%	
05.15	AI1 curve 1 maximum input	Default	10.00V
	Setting Range	05.13 ~ 10.00V	
05.16	Corresponding setting of AI1 curve 1 maximum input	Default	100.0%
	Setting Range	-100.00% ~ 100.0%	
05.17	AI1 filter time	Default	0.10s
	Setting Range	0.00s ~ 10.00s	

These parameters are used to define the relationship between the analog input voltage and the corresponding setting.

When the analog input voltage exceeds the maximum value (05.15), the maximum value is used. When the analog input voltage is less than the minimum value (05.13), the value set in 05.34 (Setting for AI1 less than minimum input) is used.

When the analog input is current input, 1mA current corresponds to 0.5 V voltages.

05.17 (AI1 filter time) is used to set the software filter time of AI1. If the analog input is liable to interference, increase the value of this parameter to stabilize the detected analog input. However, increase of the AI filter time will slow the response of analog detection. Set this parameter properly based on actual conditions.

In different applications, 100% of analog input corresponds to different nominal values. For details, refer to the description of different applications.

Two typical setting examples are shown in the following figure.

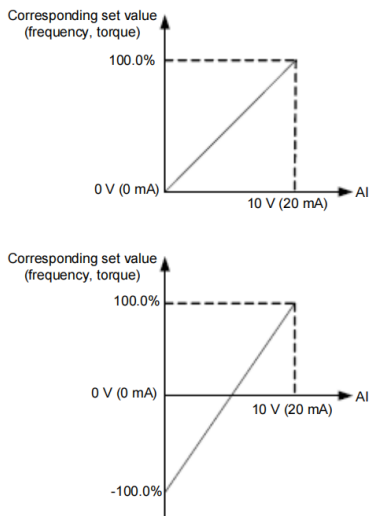

Figure Corresponding relationship between analog input and set values

05.18	AI2 curve minimum input	Default	0.00V
-------	-------------------------	---------	-------

	Setting Range	0.00V ~05.20	
05.19	Corresponding setting of AI2 curve minimum input	Default	0.0%
	Setting Range	-100.00% ~100.0%	
05.20	AI2 curve maximum input	Default	10.00V
	Setting Range	05.18 ~10.00V	
05.21	Corresponding setting of AI2 curve maximum input	Default	100.0%
	Setting Range	-100.00% ~100.0%	
05.22	AI2 filter time	Default	0.10s
	Setting Range	0.00s ~10.00s	

The method of setting AI2 functions is similar to that of setting AI1 function.

05.28	PULSE minimum input	Default	0.00kHz
	Setting Range	0.00kHz ~05.30	
05.29	Corresponding setting of pulse minimum input	Default	0.0%
	Setting Range	-100.00% ~100.0%	
05.30	Pulse maximum input	Default	50.00kHz
	Setting Range	05.28 ~50.00kHz	
05.31	Corresponding setting of pulse maximum input	Default	100.0%
	Setting Range	-100.00% ~100.0%	
05.32	PULSE filter time	Default	0.10s
	Setting Range	0.00s ~10.00s	

These parameters are used to set the relationship between DI5 pulse input and corresponding settings. The pulses can only be input by DI5. The method of setting this function is similar to that of setting AI1 function.

05.33	AI curve selection		Default	321
	Setting Range	Unit's digit	AI1 curve selection	
		1	Curve 1 (2 points, see 05.13 ~05.16)	
		2	Curve 2 (2 points, see 05.18 ~05.21)	
		3	Curve 3 (2 points, see 05.23 ~05.26)	
		4	Curve 4 (4 points, see 24.00 ~24.07)	
		5	Curve 5 (4 points, see 24.08 ~24.15)	
		Ten's digit	AI2 curve selection (1 ~5, same to AI1)	
Hundred's digit	Reserved			

The unit's digit, ten's digit of this parameter are respectively used to select the corresponding curve of AI1 and AI2. Any of the five curves can be selected for AI1, AI2

Curve 1&2 are all 2-point curves, set in group 05. Curve 4&5 are both 4-point curves, set in group 24.

The DSI-100 provides two AI terminals as standard.

05.34	Setting for AI less than minimum input		Default	000
	Setting	Unit's digit	Setting for AI1 less than minimum input	

	Range	0	Minimum value
		1	0.0%
		Ten's digit	Setting for AI2 less than minimum input (0 ~ 1, same to AI1)
		Hundred's digit	Reserved

This parameter is used to determine the corresponding setting when the analog input voltage is less than the minimum value. The unit's digit, ten's digit of this parameter respectively correspond to the setting for AI1 and AI2.

If the value of a certain digit is 0, when analog input voltage is less than the minimum input, the corresponding setting of the minimum input (05.14、05.19、05.24) is used.

If the value of a certain digit is 1, when analog input voltage is less than the minimum input, the corresponding value of this analog input is 0.0%.

05.35	DI1 delay time	Default	0.0s
	Setting Range	0.0s ~ 3600.0s	
05.36	DI2 delay time	Default	0.0s
	Setting Range	0.0s ~ 3600.0s	
05.37	DI3 delay time	Default	0.0s
	Setting Range	0.0s ~ 3600.0s	

These parameters are used to set the delay time of the AC drive when the status of DI terminals changes. Currently, only DI1, DI2 and DI3 support the delay time function.

05.38	Setting Range	DI valid mode selection 1	Default	00000
		Unit's digit	DI1 valid mode	
		0	High level valid	
		1	Low level valid	
		Ten's digit	DI2 valid mode (0 ~ 1, same as X1)	
		Hundred's digit	DI3 valid mode (0 ~ 1, same as X1)	
		Thousand's digit	DI4 valid mode (0 ~ 1, same as X1)	
Ten thousand's digit	DI5 valid mode (0 ~ 1, same as X1)			

It is used to set the valid state mode of the digital input terminal.

When it is selected to be active at high level, it is valid when the corresponding DI terminal is connected to COM, and invalid when disconnected.

Group 06 Output Terminals

DSI-100 series inverters come standard with 1 multi-function AO terminal, 1 multi-function HDO terminal, and 1 multi-function Relay output terminal.

06.01	DO function (open-collector output terminal)	Default	0
06.02	Relay function (T/A-T/B-T/C)	Default	2

The above two function codes are used to select the function of two digital outputs, among which T/A-T/B-T/C are the Relays on the control board.

The function description of the multi-function output terminal is as follows:

Value	Function	Description
0	No output	The terminal has no function.
1	AC drive running	When the AC drive is running and has output frequency (can be zero), the terminal becomes ON.
2	Fault output (stop)	When the AC drive stops due to a fault, the terminal becomes ON.
3	Frequency-level detection FDT1 output	Refer to the descriptions of 09.19 and 09.20.
4	Frequency reached	Refer to the descriptions of 09.21.
5	Zero-speed running (no output at stop)	If the AC drive runs with the output frequency of 0, the terminal becomes ON. If the AC drive is in the stop state, the terminal becomes OFF.
6	Motor overload pre-warning	The AC drive judges whether the motor load exceeds the overload pre-warning threshold before performing the protection action. If the pre-warning threshold is exceeded, the terminal becomes ON. For motor overload parameters, see the descriptions of 10.00 to 10.02.
7	AC drive overload pre-warning	The terminal becomes ON 10s before the AC drive overload protection action is performed.
8	Set count value reached	The terminal becomes ON when the count value reaches the value set in 12.08.
9	Designated count value reached	The terminal becomes ON when the count value reaches the value set in 12.09.
10	Length reached	The terminal becomes ON when the detected actual length exceeds the value set in 12.05
11	PLC cycle complete	When simple PLC completes one cycle, the terminal outputs a pulse signal with width of 250 ms.
12	Accumulative running time reached	If the accumulative running time of the AC drive exceeds the time set in 09.17, the terminal becomes ON.
13	Frequency limited	If the set frequency exceeds the frequency upper limit or lower limit and the output frequency of the AC drive reaches the upper limit or lower limit, the terminal becomes ON.
14	Torque limited	In speed control mode, if the output torque reaches the torque limit, the AC drive enters the stall protection state and meanwhile the terminal becomes ON.
15	Ready for RUN	If the AC drive main circuit and control circuit become stable, and the AC drive detects no fault and is ready for RUN, the terminal becomes ON.
16	AI1>AI2	When the input of AI1 is larger than the input of AI2, the terminal becomes ON.

17	Frequency upper limit Reached	If the running frequency reaches the upper limit, the terminal becomes ON.
18	Frequency lower limit reached (no output at stop)	If the running frequency reaches the lower limit, the terminal becomes ON. In the stop state, the terminal becomes OFF.
19	Undervoltage state output	If the AC drive is in under voltage state, the terminal becomes ON.
20	Communication setting	Refer to the communication protocol.
21	Reserved	Reserved.
22	Reserved	Reserved.
23	Zero-speed running 2 (having output at stop)	If the output frequency of the AC drive is 0, the terminal becomes ON. In the state of stop, the signal is still ON.
24	Accumulative power-on time reached	If the AC drive accumulative power-on time (08.13) exceeds the value set in 09.16, the terminal becomes ON.
25	Frequency level detection FDT2	Refer to the descriptions of 09.28 and 09.29.
26	Frequency 1 reached	Refer to the descriptions of 09.30 and 09.31.
27	Frequency 2 reached	Refer to the descriptions of 09.32 and 09.33.
28	Current 1 reached	Refer to the descriptions of 09.38 and 09.39.
29	Current 2 reached	Refer to the descriptions of 09.40 and 09.41.
30	Timing reached	If the timing function (09.42) is valid, the terminal becomes ON after the current running time of the AC drive reaches the set time.
31	All input limit exceeded	If All input is larger than the value of 09.46 (All input voltage upper limit) or lower than the value of 09.45 (All input voltage lower limit), the terminal becomes ON.
32	Load becoming 0	If the load becomes 0, the terminal becomes ON.
33	Reverse running	If the AC drive is in the reverse running state, the terminal Becomes ON.
34	Zero current state	Refer to the descriptions of 09.28 and 09.29.
35	Module temperature reached	If the heatsink temperature of the inverter module (08.07) reaches the set module temperature threshold (09.47), the terminal becomes ON.
36	Software current limit exceeded	Refer to the descriptions of 09.36 and 09.37.
37	Frequency lower limit reached (having output at stop)	If the running frequency reaches the lower limit, the terminal becomes ON. In the stop state, the signal is still ON.
38	Alarm output	If a fault occurs on the AC drive and the AC drive continues to run, the terminal outputs the alarm signal.
39	Reserved	Reserved
40	Current running time reached	If the current running time of AC drive exceeds the value of 09.53, the terminal becomes ON

06.06	DO function selection (Pulse output terminal)	Default	0
-------	---	---------	---

06.07	AO1 function selection	Default	0
-------	------------------------	---------	---

The output pulse frequency of the DO terminal ranges from 0.01 kHz to 06.09. The value of 06.09 is between 0.01 kHz and 100.00 kHz.

The output range of AO1 is 0–10 V or 0–20 mA.

The relationship between pulse and analog output ranges and corresponding functions is listed in the following table.

Value	Function	Range (Corresponding to Pulse or Analog Output Range 0.0%–100.0%)
0	Running frequency	0 to maximum output frequency
1	Set frequency	0 to maximum output frequency
2	Output current	0 to 2 times of rated motor current
3	Output torque (absolute value)	0 to 2 times of rated motor torque
4	Output power	0 to 2 times of rated power
5	Output voltage	0 to 1.2 times of rated AC drive voltage
6	Pulse input	0.01kHz ~100.00kHz
7	AI1	0V ~10V
8	AI2	0V ~10V (Or 0 ~20mA)
9	Reserved	Reserved
10	Length	0 ~maximum set length
11	Count value	0 ~maximum count value
12	Communication setting	0.0% ~100.0%
13	Motor rotational speed	0 ~rotational speed corresponding to Max. output frequency
14	Output current	0.0A ~1000.0A
15	Output voltage	0.0V ~1000.0V

06.10	AO1 offset coefficient	Default	0.0%
	Setting Range	-100.0% ~+100.0%	
06.11	AO1 gain	Default	1.00
	Setting Range	-10.00 ~+10.00	

These parameters are used to correct the zero drift of analog output and the output amplitude deviation. They can also be used to define the desired AO curve.

If "b" represents zero offset, "k" represents gain, "Y" represents actual output, and "X" represents standard output, the actual output is: $Y = kX + b$.

The zero offset coefficient 100% of AO1 and AO2 corresponds to 10 V (or 20 mA). The standard output refers to the value corresponding to the analog output of 0 to 10 V (or 0 to 20 mA) with no zero offset or gain adjustment.

For example, if the analog output is used as the running frequency, and it is expected that the output is 8 V (or 16mA)when the frequency is 0 and 3 V (or 6mA)at the maximum frequency, the gain shall be set to -0.50, and the zero offset shall be set to 80%.

Without zero offset or gain

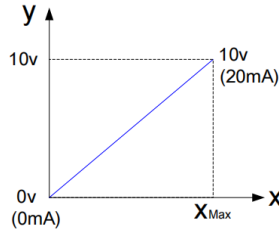

Output schematic with no offset or gain

Voltage type

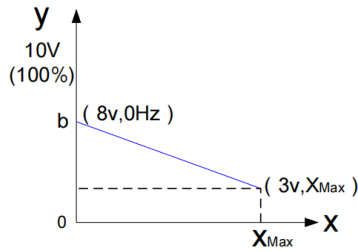

Zero offset $b = y - kx = y (x=0) = 8v$

Zero offset coefficient is 100% corresponds to 10v, so $b=8v$

Zero offset ratio $= \frac{8v}{10v} \times 100\% = 80\%$

$$k = \frac{y-b}{x} = \frac{\text{actual output}-b}{\text{Standard output}} = \frac{3v-8v}{10v} = -0.5$$

Schematic diagram of output with zero offset or gain (voltage type)

Current type

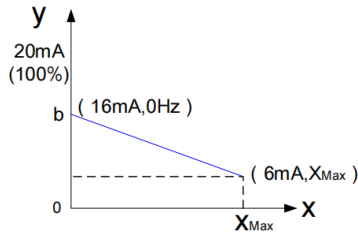

Zero offset $b = y - kx = y (x=0) = 16mA$

Zero offset coefficient is 100% corresponds to 20mA,

so $b=16mA$, Zero offset ratio $= \frac{16mA}{20mA} \times 100\% = 80\%$

$$k = \frac{y-b}{x} = \frac{\text{actual output}-b}{\text{Standard output}} = \frac{6mA-16mA}{20mA} = -0.5$$

Schematic diagram of output with zero offset or gain (Current type)

06.17	HDO output delay time	Default	0.0s
	Setting Range	0.0s ~3600.0s	
06.18	Relay1 output delay time	Default	0.0s
	Setting Range	0.0s ~3600.0s	

These parameters are used to set the delay time of output terminals DO, Relay 1 from status change to actual output.

06.22	DO valid mode selection		Default	00000
	Setting Range	Unit's digit	HDO valid mode	
		0	Positive logic	
		1	Negative logic	
		Ten's digit	Relay1 valid mode(0 ~1, same as HDO)	
		Hundred's digit	Reserved	
		Thousand's digit	Reserved	
Ten thousand's digit	Reserved			

It is used to set the logic of output terminals HDO, Relay1.

0: Positive logic

The output terminal is valid when being connected with COM, and invalid when being disconnected from COM.

1: Negative logic

The output terminal is invalid when being connected with COM, and valid when being disconnected from COM.

Group 07 Start/Stop Control

07.00	Start mode		Default	0
	Setting Range	0	Direct start	
		1	Rotational speed tracking restart	
		2	Pre-excited start (asynchronous motor)	

0: Direct start

- If the DC braking time is set to 0, the AC drive starts to run at the startup frequency.
- If the DC braking time is not 0, the AC drive performs DC braking first and then starts to run at the startup frequency. It is applicable to small-inertia load application where the motor is likely to rotate at startup.

1: Rotational speed tracking restart

The AC drive judges the rotational speed and direction of the motor first and then starts at the tracked frequency. Such smooth start has no impact on the rotating motor. It is applicable to the restart upon instantaneous power failure of large-inertia load. To ensure the performance of rotational speed tracking restart, set the motor parameters in group P1 correctly.

2: Pre-excited start (asynchronous motor)

It is valid only for asynchronous motor and used for building the magnetic field before the motor runs. For pre-excited current and pre-excited time, see parameters of 07.05 and 07.06.

- If the pre-excited time is 0, the AC drive cancels pre-excitation and starts to run at startup frequency.
- If the pre-excited time is not 0, the AC drive pre-excites first before startup, improving the dynamic response of the motor.

07.01	Rotational speed tracking mode		Default	0
	Setting Range	0	From frequency at stop	
		1	From zero speed	
		2	From maximum frequency	

To complete the rotational speed tracking process within the shortest time, select the proper mode in

which the AC drive tracks the motor rotational speed.

0: From frequency at stop

It is the commonly selected mode.

1: From zero frequency

It is applicable to restart after a long time of power failure.

2: From the maximum frequency, it is applicable to the power-generating load.

07.02	Rotational speed tracking speed	Default	20
	Setting Range	1 ~ 100	

In the rotational speed tracking restart mode, select the rotational speed tracking speed. The larger the value is, the faster the tracking is. However, too large value may cause unreliable tracking.

07.03	Startup frequency	Default	0.00Hz
	Setting Range	0.00Hz ~ 10.00Hz	
07.04	Startup frequency holding time	Default	0.0s
	Setting Range	0.0s ~ 100.0s	

To ensure the motor torque at AC drive startup, set a proper startup frequency. In addition, to build excitation when the motor starts up, the startup frequency must be held for a certain period.

The startup frequency (07.03) is not restricted by the frequency lower limit. If the set target frequency is lower than the startup frequency, the AC drive will not start and stays in the standby state.

During switchover between forward rotation and reverse rotation, the startup frequency holding time is disabled. The holding time is not included in the acceleration time but in the running time of simple PLC.

Example 1:

01.03 = 0 The frequency source is digital setting.

01.08 = 2.00Hz The digital setting frequency is 2.00 Hz.

07.03 = 5.00Hz The startup frequency is 5.00 Hz.

07.04 = 2.0s The startup frequency holding time is 2.0s.

In this example, the AC drive stays in the standby state and the output frequency is 0.00 Hz.

Example 2:

01.03 = 0 The frequency source is digital setting.

01.08 = 10.00Hz The digital setting frequency is 10.00 Hz.

07.03 = 5.00Hz The startup frequency is 5.00 Hz.

07.04 = 2.0s The startup frequency holding time is 2.0s.

In this example, the AC drive accelerates to 5.00 Hz, and then accelerates to the set frequency 10.00 Hz after 2s.

Startup DC braking is generally used during restart of the AC drive after the rotating motor stops. Pre-excitation is used to make the AC drive build magnetic field for the asynchronous motor before startup to improve the responsiveness.

Startup DC braking is valid only for direct start (07.00 = 0). In this case, the AC drive performs DC braking at the set startup DC braking current. After the startup DC braking time, the AC drive starts to run. If the startup DC braking time is 0, the AC drive starts directly without DC braking. The larger the startup DC braking current is, the larger the braking force is.

If the startup mode is pre-excited start (07.00 = 3), the AC drive builds magnetic field based on the set pre-excited current. After the pre-excited time, the AC drive starts to run. If the pre-excited time is 0, the AC drive starts directly without pre-excitation.

The startup DC braking current or pre-excited current is a percentage relative to the base value.

07.05	Start DC braking current / pre-excitation current	Default	0%
	Setting Range	0% ~ 100%	
07.06	Start DC braking time / pre-excitation time	Default	0.0s
	Setting Range	0.0s ~ 100.0s	

Start DC braking, generally used to stop the running motor and then start it. Pre-excitation is used to

make the asynchronous motor establish a magnetic field before starting, and improve the response speed.

Start DC braking is only valid when the start mode is direct start. At this time, the inverter first performs DC braking according to the set starting DC braking current, and then starts to run after the starting DC braking time. If the DC braking time is set to 0, it will start directly without DC braking. The greater the DC braking current, the greater the braking force.

If the starting mode is asynchronous machine pre-excitation start, the inverter will first establish a magnetic field according to the set pre-excitation current, and then start running after the set pre-excitation time. If the pre-excitation time is set to 0, it will start directly without going through the pre-excitation process.

The starting DC braking current/pre-excitation current is a percentage relative to the rated current of the inverter.

07.07	Acceleration/Deceleration mode		Default	0
	Setting Range	0	Linear acceleration/deceleration	
		1	S-curve acceleration/deceleration A	
		2	S-curve acceleration/deceleration B	

It is used to set the frequency change mode during the AC drive start and stop process.

0: Linear acceleration/deceleration

The output frequency increases or decreases in linear mode. The DSI-100 provides four group of acceleration/deceleration time, which can be selected by using 05.00 to 05.08.

1: S-curve acceleration/deceleration A

The output frequency increases or decreases along the S curve. This mode is generally used in the applications where start and stop processes are relatively smooth, such as elevator and conveyor belt. 07.08 and 07.09 respectively define the time proportions of the start segment and the end segment.

2: S-curve acceleration/deceleration B

In this curve, the rated motor frequency f_b is always the inflexion point. This mode is usually used in applications where acceleration/deceleration is required at the speed higher than the rated frequency.

When the set frequency is higher than the rated frequency, the acceleration/deceleration time is:

$$t = \left(\frac{4}{9} \times \left(\frac{f}{f_b} \right)^2 + \frac{5}{9} \right) \times T$$

In the formula, f is the set frequency, f_b is the rated motor frequency and T is the acceleration time from 0 Hz to f_b .

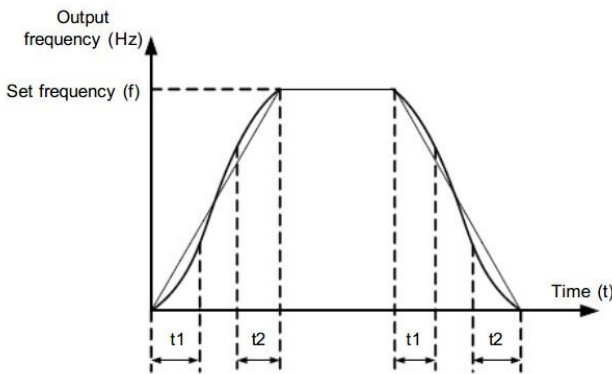

S-curve acceleration/deceleration A

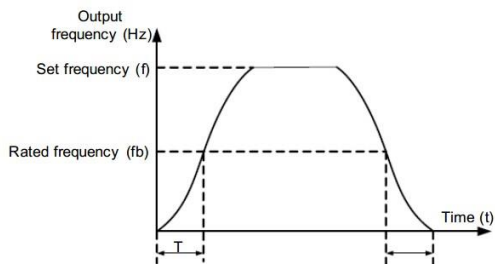

S-curve acceleration/deceleration B

07.08	Time proportion of S-curve start segment	Default	30.0%
	Setting Range	0.0% ~ (100.0%-07.09)	
07.09	Time proportion of S-curve end segment	Default	30.0%
	Setting Range	0.0% ~ (100.0%-07.08)	

These two parameters respectively define the time proportions of the start segment and the end segment of S-curve acceleration/deceleration. They must satisfy the requirement: 07.08 + 07.09 ≤ 100.0%.

In Figure, t1 is the time defined in 07.08, within which the slope of the output frequency change increases gradually. t2 is the time defined in 07.09, within which the slope of the output frequency change gradually decreases to 0. Within the time between t1 and t2, the slope of the output frequency change remains unchanged, that is, linear acceleration/deceleration.

07.10	Stop mode	Default	0
	Setting Range	0	Decelerate to stop
		1	Coast to stop

0: Decelerate to stop

After the stop command is enabled, the AC drive decreases the output frequency according to the deceleration time and stops when the frequency decreases to zero.

1: Coast to stop

After the stop command is enabled, the AC drive immediately stops the output. The motor will coast to stop based on the mechanical inertia.

07.11	Initial frequency of stop DC braking	Default	0.00Hz
	Setting Range	0.00Hz ~ maximum frequency	
07.12	Waiting time of stop DC braking	Default	0.0s
	Setting Range	0.0s ~ 36.0s	
07.13	Stop DC braking current	Default	0%
	Setting Range	0% ~ 100%	
07.14	Stop DC braking time	Default	0.0s
	Setting Range	0.0s ~ 36.0s	

07.11 (Initial frequency of stop DC braking)

During the process of decelerating to stop, the AC drive starts DC braking when the running frequency is lower than the value set in 07.11.

07.12 (Waiting time of stop DC braking)

When the running frequency decreases to the initial frequency of stop DC braking, the AC drive stops output for a certain period and then starts DC braking. This prevents faults such as overcurrent caused due to DC braking at high speed.

07.13 (Stop DC braking current)

This parameter specifies the output current at DC braking and is a percentage relative to the base value.

- If the rated motor current is less than or equal to 80% of the rated AC drive current, the base value is the rated motor current.

- If the rated motor current is greater than 80% of the rated AC drive current, the base value is 80% of the rated AC drive current.

07.14 (Stop DC braking time)

This parameter specifies the holding time of DC braking. If it is set to 0, DC braking is cancelled.

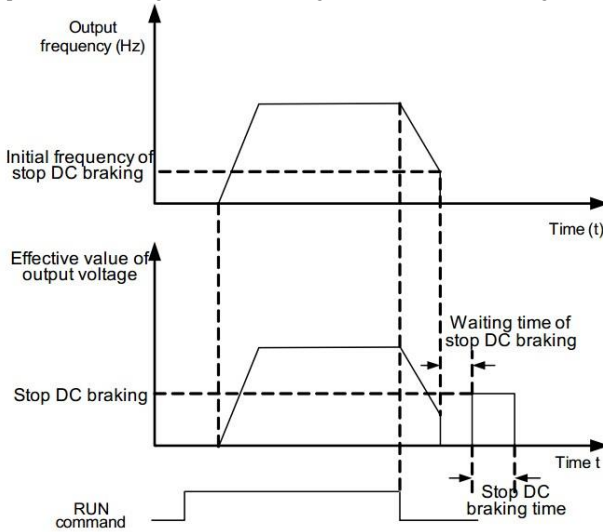

Stop DC braking process

07.15	Brake use ratio	Default	100%
	Setting Range	0% ~100%	

It is valid only for the AC drive with internal braking unit and used to adjust the duty ratio of the braking unit. The larger the value of this parameter is, the better the braking result will be. However, too larger value causes great fluctuation of the AC drive bus voltage during the braking process.

Group 08 Keyboard and Display

08.01	MF.K function selection		Default	0
	Setting Range	0	MF key disabled	
		1	Switchover between operation panel control and remote command control (terminal or communication)	
		2	Switchover between forward rotation and reverse rotation	
		3	Forward JOG	
4	Reverse JOG			

MF.K key refers to multifunctional key. You can set the function of the MF.K key by using this parameter. You can perform switchover by using this key both in stop or running state.

0: MF.K key disabled

1: Switchover between operation panel control and remote command control (terminal or communication).

You can perform switchover from the current command source to the operation panel control (local operation). If the current command source is operation panel control, this key is invalid.

2: Switchover between forward rotation and reverse rotation

You can change the direction of the frequency reference by using the MF.K key. It is valid only when the current command source is operation panel control.

3: Forward JOG

You can perform forward JOG (FJOG) by using the MF.K key.

4: Reverse JOG

You can perform reverse JOG (RJOG) by using the MF.K key.

08.02	STOP/RESET key function		Default	1
	Setting Range	0	STOP/RESET key enabled only in keypad control	
		1	STOP/RESET key enabled in any operation mode	

08.03	LED display running parameters 1		Default	1F
	Setting Range	0000~FFFF	<p>If a parameter needs to be displayed during the running, set the corresponding bit to 1, and set 08.03 to the hexadecimal equivalent of this binary number.</p>	

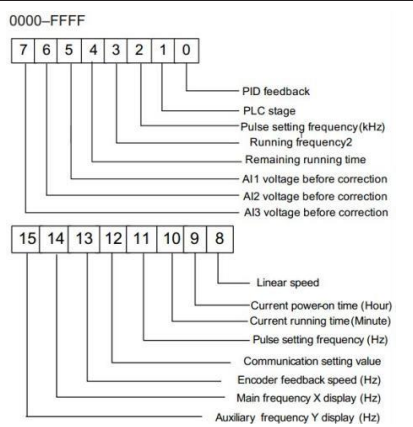
LED display running parameters 2		Default	0
08.04	Setting Range	0000~FFFF	<p>0000~FFFF</p>  <p>If a parameter needs to be displayed during the running, set the corresponding bit to 1, and set 08.03 to the hexadecimal equivalent of this binary number.</p>

Running display parameters are used to set the parameters that can be viewed when the inverter is running.

The maximum number of status parameters available for viewing is 32. The status parameters to be displayed are selected according to the binary digits of the parameter values of 08.03 and 08.04. The display sequence starts from the lowest digit of 08.03.

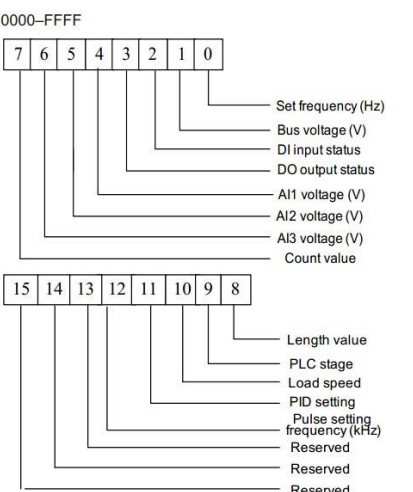
LED display stop parameters		Default	0
08.05	Setting Range	0000~FFFF	<p>0000~FFFF</p>  <p>If a parameter needs to be displayed during the running, set the corresponding bit to 1, and set 08.05 to the hexadecimal equivalent of this binary number.</p>

08.06	Load speed display coefficient	Default	1.0000
	Setting Range	0.0001 ~ 6.5000	

This parameter is used to adjust the relationship between the output frequency of the AC drive and the load speed. For details, see the description of 08.12.

08.07	Heatsink temperature of inverter Module	Default	—
	Setting Range	0.0°C~100.0°C	

It is used to display the insulated gate bipolar transistor (IGBT) temperature of the inverter module, and the IGBT overheat protection value of the inverter module depends on the model.

08.08	Temporary software version	Default	—
	Setting Range	—	

It is used to display the temporary software version of the control board.

08.09	Accumulative running time	Default	0 hour
	Setting Range	0h ~ 65535h	

It is used to display the accumulative running time of the AC drive. After the accumulative running time reaches the value set in 09.17, the terminal with the digital output function 12 becomes ON.

08.10	Product number	Default	
	Setting Range	AC drive product number	
08.11	Software version	Default	
	Setting Range	Software version of control board	

08.12	Number of decimal places for load speed display		Default	1
	Setting Range	0	0 decimal place	
		1	1 decimal place	
		2	2 decimal place	
		3	3 decimal places	

08.12 is used to set the number of decimal places for load speed display. The following gives an example to explain how to calculate the load speed:

Assume that 08.06 (Load speed display coefficient) is 2.000 and 08.12 is 2 (2 decimal places).

When the running frequency of the AC drive is 40.00 Hz, the load speed is $40.00 \times 2.000 = 80.00$ (display of 2 decimal places).

If the AC drive is in the stop state, the load speed is the speed corresponding to the set frequency, namely, "set load speed". If the set frequency is 50.00 Hz, the load speed in the stop state is $50.00 \times 2.000 = 100.00$ (display of 2 decimal places).

08.13	Accumulative power-on time	Default	—
	Setting Range	0 ~ 65535 hour	

It is used to display the accumulative power-on time of the AC drive since the delivery. If the time reaches the set power-on time (09.17), the terminal with the digital output function 24 becomes ON.

08.14	Accumulative power consumption	Default	-
	Setting Range	0 ~ 65535 kWh	

It is used to display the accumulative power consumption of the AC drive until now.

Group 09 Auxiliary Functions

09.00	JOG running frequency	Default	2.00Hz
	Setting Range	0.00Hz ~maximum frequency	
09.01	JOG acceleration time	Default	20.0s
	Setting Range	0.0s ~6500.0s	
09.02	JOG deceleration time	Default	20.0s
	Setting Range	0.0s ~6500.0s	

These parameters are used to define the set frequency and acceleration/deceleration time of the AC drive when jogging. The startup mode is "Direct start" (07.00 = 0) and the stop mode is "Decelerate to stop" (07.10 = 0) during jogging.

09.03	Acceleration time 2	Default	Model dependent
	Setting Range	0.0s ~6500.0s	
09.04	Deceleration time 2	Default	Model dependent
	Setting Range	0.0s ~6500.0s	
09.05	Acceleration time 3	Default	Model dependent
	Setting Range	0.0s ~6500.0s	
09.06	Deceleration time 3	Default	Model dependent
	Setting Range	0.0s ~6500.0s	
09.07	Acceleration time 4	Default	Model dependent
	Setting Range	0.0s ~6500.0s	
09.08	Deceleration time 4	Default	Model dependent
	Setting Range	0.0s ~500.0s	

The DSI-100 provides a total of four groups of acceleration/deceleration time, that is, the preceding three groups and the group defined by 01.17 and 01.18. Definitions of four groups are completely the same. You can switch over between the four groups of acceleration/deceleration time through different state combinations of X terminals. For more details, see the descriptions of 05.01 to 05.05.

09.09	Jump frequency 1	Default	0.00Hz
	Setting Range	0.00Hz ~maximum frequency	
09.10	Jump frequency 2	Default	0.00Hz
	Setting Range	0.00 Hz ~maximum frequency	
09.11	Frequency jump amplitude	Default	0.00Hz
	Setting Range	0.00 ~maximum frequency	

If the set frequency is within the frequency jump range, the actual running frequency is the jump frequency close to the set frequency. Setting the jump frequency helps to avoid the mechanical resonance point of the load.

The DSI-100 supports two jump frequencies. If both are set to 0, the frequency jump function is disabled. The principle of the jump frequencies and jump amplitude is shown in the following figure.

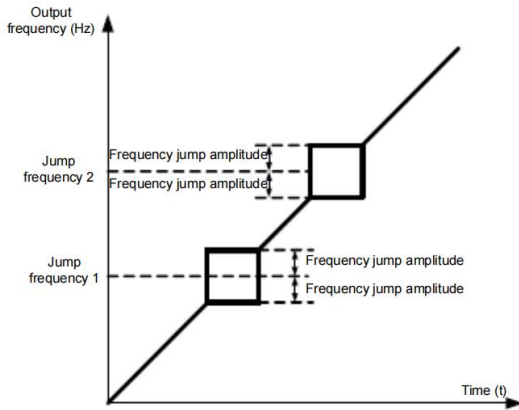

Principle of the jump frequencies and jump amplitude

09.12	Forward/Reverse rotation dead-zone time	Default	0.0s
	Setting Range	0.0s ~ 3000.0s	

It is used to set the time when the output is 0Hz at transition of the AC drive forward rotation and reverse rotation, as shown in the following figure.

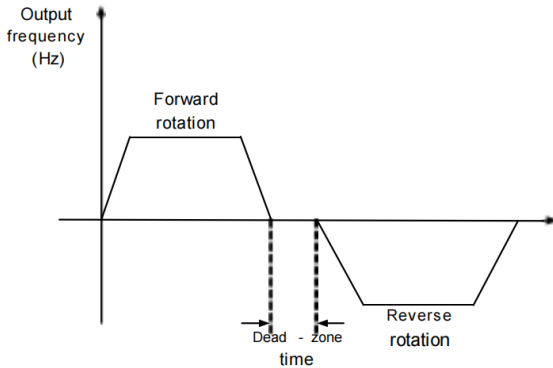

Forward/Reverse rotation dead-zone time

09.13	Reverse control	Default	0
	Setting Range	0	Enabled
		1	Disabled

It is used to set whether the AC drive allows reverse rotation. In the applications where reverse rotation is prohibited, set this parameter to 1.

09.14	Running mode when set frequency lower than frequency lower limit	Default	0
	Setting Range	0	Run at frequency lower limit
		1	Stop
	2	Run at zero speed	

It is used to set the AC drive running mode when the set frequency is lower than the frequency lower limit. The DSI-100 provides three running modes to satisfy requirements of various applications.

09.15	Droop control	Default	0.00Hz
	Setting Range	0.00Hz ~10.00Hz	

This function is used for balancing the workload allocation when multiple motors are used to drive the same load. The output frequency of the AC drives decreases as the load increases. You can reduce the workload of the motor under load by decreasing the output frequency for this motor, implementing workload balancing between multiple motors.

09.16	Accumulative power-on time threshold	Default	0h
	Setting Range	0h ~65000h	

If the accumulative power-on time (08.13) reaches the value set in this parameter, the corresponding DO terminal becomes ON.

09.17	Accumulative running time threshold	Default	0h
	Setting Range	0h ~65000h	

It is used to set the accumulative running time threshold of the AC drive. If the accumulative running time (08.09) reaches the value set in this parameter, the corresponding DO terminal becomes ON.

09.18	Startup protection		D	0
	Setting Range	0	No	
		1	Yes	

This parameter is used to set whether to enable the safety protection. If it is set to 1, the AC drive does not respond to the run command valid upon AC drive power-on (for example, an input terminal is ON before power-on). The AC drive responds only after the run command is canceled and becomes valid again.

In addition, the AC drive does not respond to the run command valid upon fault reset of the AC drive. The run protection can be disabled only after the run command is canceled.

In this way, the motor can be protected from responding to run commands upon power-on or fault reset in unexpected conditions.

09.19	Frequency detection value(FDT1)	Default	50.00Hz
	Setting Range	0.00Hz ~maximum frequency	
09.20	Frequency detection hysteresis (FDT hysteresis 1)	Default	5.0%
	Setting Range	0.0% ~100.0% (FDT1 level)	

If the running frequency is higher than the value of 09.19, the corresponding DO terminal becomes ON. If the running frequency is lower than value of 09.19, the DO terminal goes OFF

These two parameters are respectively used to set the detection value of output frequency and hysteresis value upon cancellation of the output. The value of 09.20 is a percentage of the hysteresis frequency to the frequency detection value (09.19).

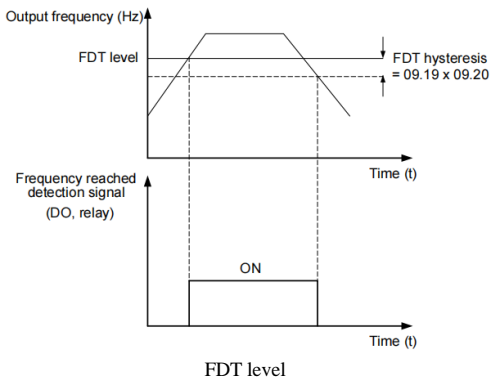

09.21	Detection range of frequency reached	Default	0.0%
	Setting Range	0.00 ~ 100% (maximum frequency)	

If the AC drive running frequency is within the certain range of the set frequency, the corresponding DO terminal becomes ON.

This parameter is used to set the range within which the output frequency is detected to reach the set frequency. The value of this parameter is a percentage relative to the maximum frequency. The detection range of frequency reached is shown in the following figure.

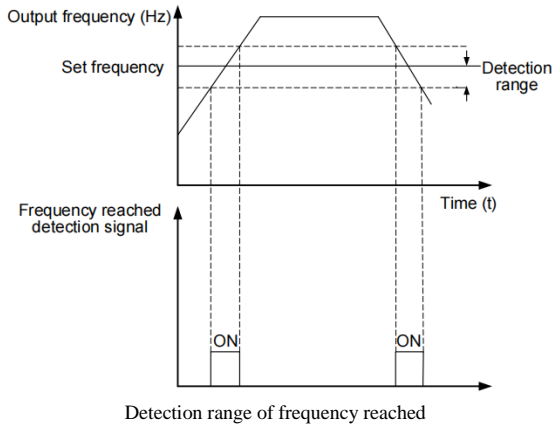

9.22	Jump frequency during acceleration/deceleration	Default	0
	Setting Range	0: Disabled; 1: Enabled	

It is used to set whether the jump frequencies are valid during acceleration/deceleration.

When the jump frequencies are valid during acceleration/deceleration, and the running frequency is within the frequency jump range, the actual running frequency will jump over the set frequency jump amplitude (rise directly from the lowest jump frequency to the highest jump frequency). The following figure shows the diagram when the jump frequencies are valid during acceleration/deceleration.

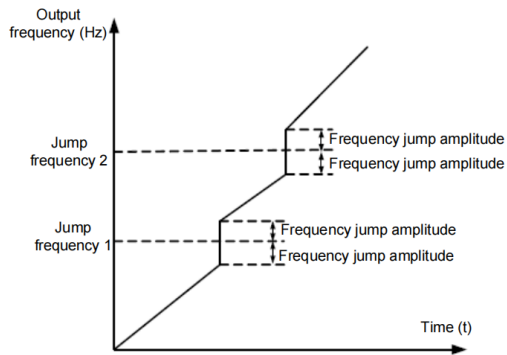
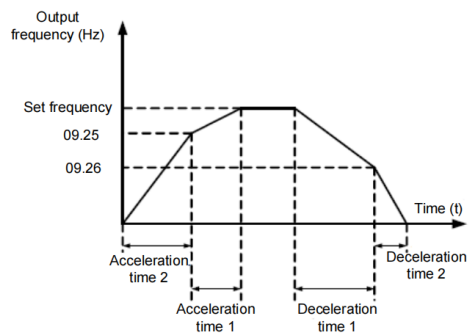

Diagram when the jump frequencies are valid during acceleration/deceleration

09.25	Frequency switchover point between acceleration time 1 and acceleration time 2	Default	0.00Hz
	Setting Range	0.00Hz ~ maximum frequency	

09.26	Frequency switchover point between deceleration time 1 and deceleration time 2	Default	0.00Hz
	Setting Range	0.00Hz ~maximum frequency	

This function is valid when motor 1 is selected and acceleration/deceleration time switchover is not performed by means of DI terminal. It is used to select different groups of acceleration/deceleration time based on the running frequency range rather than DI terminal during the running process of the AC drive.



Acceleration/deceleration time switchover

During acceleration, if the running frequency is smaller than the value of 09.25, acceleration time 2 is selected. If the running frequency is larger than the value of 09.25, acceleration time 1 is selected.

During deceleration, if the running frequency is larger than the value of 09.26, deceleration time 1 is selected. If the running frequency is smaller than the value of 09.26, deceleration time 2 is selected.

09.27	Terminal JOG preferred	Default	0
	Setting Range	0: Disabled; 1: Enabled	

It is used to set whether terminal JOG is preferred.

If terminal JOG is preferred, the AC drive switches to terminal JOG running state when there is a terminal JOG command during the running process of the AC drive.

09.28	Frequency detection value (FDT2)	Default	50.00Hz
	Setting Range	0.00Hz ~maximum frequency	
09.29	Frequency detection hysteresis (FDT hysteresis 2)	Default	5.0%
	Setting Range	0.0% ~100.0 % (FDT2 level)	

The frequency detection function is the same as FDT1 function. For details, refer to the descriptions of 09.19 and 09.20.

09.30	Any frequency reaching detection value 1	Default	50.00Hz
	Setting Range	0.00Hz ~maximum frequency	
09.31	Any frequency reaching detection amplitude 1	Default	0.0%
	Setting Range	0.0%~100.0%(maximum frequency)	
09.32	Any frequency reaching detection value 2	Default	50.00Hz
	Setting Range	0.00Hz ~maximum frequency	
09.33	Any frequency reaching detection amplitude 2	Default	0.0%
	Setting Range	0.0%~100.0%(maximum frequency)	

If the output frequency of the AC drive is within the positive and negative amplitudes of the any frequency reaching detection value, the corresponding DO becomes ON.

The DSI-100 provides two groups of any frequency reaching detection parameters, including frequency detection value and detection amplitude, as shown in the following figure.

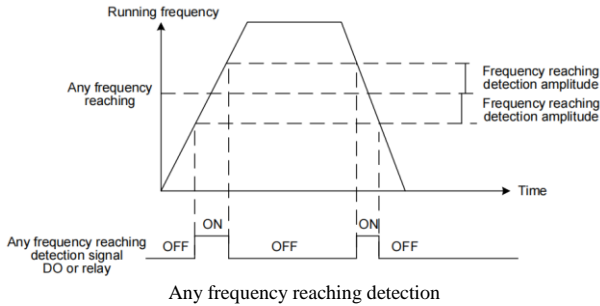

09.34	Zero current detection level	Default	5.0%
	Setting Range	0.0% ~ 300.0% (rated motor current)	
09.35	Zero current detection delay time	Default	0.10s
	Setting Range	0.00s ~ 600.00s	

If the output current of the AC drive is equal to or less than the zero current detection level and the duration exceeds the zero current detection delay time, the corresponding DO becomes ON. The zero current detection is shown in the following figure.

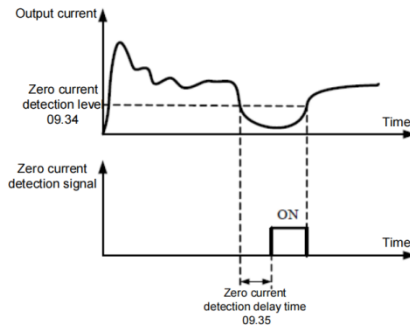

09.36	Output overcurrent threshold	Default	200.0%
	Setting Range	0.0% (no detection); 0.1% ~ 300.0% (rated motor current)	
09.37	Output overcurrent detection delay	Default	0.00s
	Setting Range	0.00s ~ 600.00s	

If the output current of the AC drive is equal to or higher than the overcurrent threshold and the duration exceeds the detection delay time, the corresponding DO becomes ON.

The output overcurrent detection function is shown in the following figure.

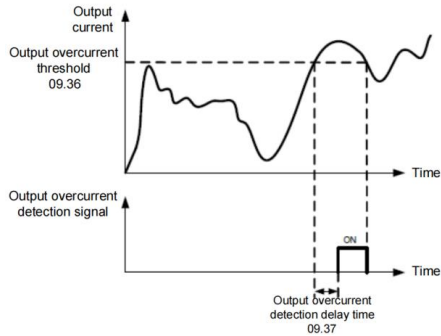

Output overcurrent detection

09.38	Any current reaching 1	Default	100.0%
	Setting Range	0.0% ~ 300.0%(rated motor current)	
09.39	Any current reaching 1 amplitude	Default	0.0%
	Setting Range	0.0% ~ 300.0%(rated motor current)	
09.40	Any current reaching 2	Default	100.0%
	Setting Range	0.0% ~ 300.0%(rated motor current)	
09.41	Any current reaching 2 amplitude	Default	0.0%
	Setting Range	0.0% ~ 300.0%(rated motor current)	

If the output current of the AC drive is within the positive and negative amplitudes of any current reaching detection value, the corresponding DO becomes ON.

The DSI-100 provides two groups of any current reaching detection parameters, including current detection value and detection amplitudes, as shown in the following figure.

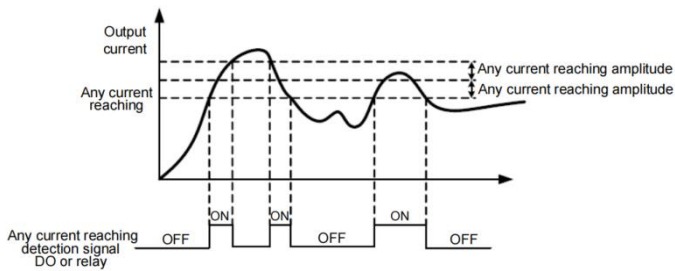

Any current reaching detection

09.42	Timing function	Default	0
	Setting Range	0	Disabled
		1	Enabled
09.43	Timing duration	Default	0
	Setting Range	0	09.44
		1	AI1
		2	AI2
		3	AI3 (Keyboard Potentiometer)
(100% of analog input corresponds to the value of 09.44)			

09.44	Timing duration	Default	0.0Min
	Setting Range	0.0Min ~6500.0Min	

These parameters are used to implement the AC drive timing function.

If 09.42 is set to 1, the AC drive starts to time at startup. When the set timing duration is reached, the AC drive stops automatically and meanwhile the corresponding DO becomes ON.

The AC drive starts timing from 0 each time it starts up and the remaining timing duration can be queried by 00.20.

The timing duration is set in 09.43 and 09.44, in unit of minute.

09.45	AI1 input voltage lower limit	Default	3.10V
	Setting Range	0.00V ~09.46	
09.46	AI1 input voltage upper limit	Default	6.80V
	Setting Range	09.45 ~10.00V	

These two parameters are used to set the limits of the input voltage to provide protection on the AC drive. When the AI1 input is larger than the value of 09.46 or smaller than the value of 09.45, the corresponding DO becomes ON, indicating that VS input exceeds the limit.

09.47	Module temperature threshold	Default	75°C
	Setting Range	0°C~ 100°C	

When the heatsink temperature of the AC drive reaches the value of this parameter, the corresponding DO becomes ON, indicating that the module temperature reaches the threshold.

09.48	Cooling fan control	Default	0
	Setting Range	0 : Fan working during running; 1 : Fan working continuously	

It is used to set the working mode of the cooling fan. If this parameter is set to 0, the fan works when the AC drive is in running state. When the AC drive stops, the cooling fan works if the heatsink temperature is higher than 40°C, and stops working if the heatsink temperature is lower than 40°C.

If this parameter is set to 1, the cooling fan keeps working after power-on.

09.49	Current running time reached	Default	0.0Min
	Setting Range	0.0Min ~6500.0Min	

Group 10 Faults and Protections

10.00	Motor overload protection selection		Default	1
	Setting Range	0	Disabled	
		1	Enabled	
10.01	Motor overload protection gain		Default	1
	Setting Range		0.20 ~ 10.00	

In order to effectively protect different load motors, this parameter needs to be set according to the overload capacity of the motor. The motor overload protection is an inverse time curve, and the motor overload protection curve is shown in below:

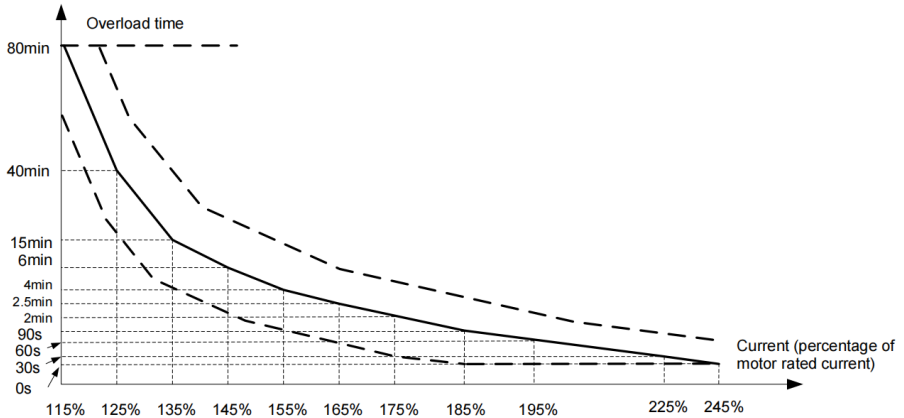

1) Under the condition that the running current of the motor reaches 175% of the rated current of the motor, the motor overload (Err11) will be reported after continuous operation for 2 minutes;

Under the condition that the running current of the motor reaches 115% times the rated current of the motor, it will report the motor overload (Err11) after continuous running for 80 minutes.

For example: motor rated current 100A

If 12.01 is set to 1.00, then when the motor running current reaches 125% (125A) of 100A, after 40 minutes, the inverter will report the motor overload fault;

If 12.01 is set to 1.20, then when the motor running current reaches 125% (125A) of 100A, after 40*1.2=48 minutes, the inverter will report the motor overload fault;

The longest overload is 80 minutes, and the shortest time is 10 seconds.

2) Example of motor overload protection adjustment: the motor needs to run for 2 minutes under the condition of 150% motor current to report overload. It can be known from the motor overload curve that the current of 150% (I) is between 145% (I1) and 155% (I2).) within the current range of 145% of the current for 6 minutes (T1) and 155% of the current for 4 minutes (T2), then the 5-minute overload of 150% of the motor's rated current under the default setting can be calculated as follows:

$$T = T1 + (T2 - T1) * (I - I1) / (I2 - I1) = 4 + (6 - 4) * (150 - 145) / (155 - 145) = 5 \text{ (minutes)}$$

Therefore, it can be concluded that the motor needs to report overload for 2 minutes under the condition of 150% motor current, and the motor overload protection gain is:

$$10.01 = 2 \div 5 = 0.4$$

Note: The user needs to correctly set the value of 10.01 according to the actual overload capacity of the motor. If this parameter is set too large, the motor may be overheated and damaged, and the inverter will not alarm and protect in time!

3) Motor overload warning coefficient means: when the motor overload detection level reaches the set value of this parameter, the multi-function output terminal DO or the fault relay (RELAY) outputs the motor overload pre-alarm signal. This parameter is based on the motor running continuously under a certain overload point. The time percentage calculation of overload failure is not reported.

For example: when the motor overload protection gain is set to 1.00 and the motor overload warning coefficient is set to 80%, if the motor current reaches 145% of the rated motor current and continues to run for 4.8 minutes (80% × 6 minutes), the multi-function output terminal DO Or the fault relay RELAY outputs the motor overload warning signal.

10.02	Motor overload pre-warning coefficient	Default	80%
	Setting Range	50% ~ 100%	

This function is used to give a warning signal to the control system via DO before motor overload protection. This parameter is used to determine the percentage, at which pre-warning is performed before motor overload. The larger the value is, the less advanced the pre-warning will be.

When the accumulative output current of the AC drive is greater than the value of the overload inverse time-lag curve multiplied by 10.02, the DO terminal on the AC drive allocated with function 6 (Motor overload pre-warning) becomes ON.

10.03	Overvoltage stall gain	Default	0
	Setting Range	0 (no stall overvoltage) ~ 100	
10.04	Overvoltage stall protective voltage	Default	130%
	Setting Range	120% ~ 150%	

When the DC bus voltage exceeds the value of 10.04 (Overvoltage stall protective voltage) during deceleration of the AC drive, the AC drive stops deceleration and keeps the present running frequency. After the bus voltage declines, the AC drive continues to decelerate.

10.03 (Overvoltage stall gain) is used to adjust the overvoltage suppression capacity of the AC drive. The larger the value is, the greater the overvoltage suppression capacity will be.

In the prerequisite of no overvoltage occurrence, set 10.03 to a small value. For small-inertia load, the value should be small. Otherwise, the system dynamic response will be slow. For large-inertia load, the value should be large. Otherwise, the suppression result will be poor and an overvoltage fault may occur.

If the overvoltage stall gain is set to 0, the overvoltage stall function is disabled.

10.05	Overcurrent stall gain	Default	20
	Setting Range	0 ~ 100	
10.06	Overcurrent stall protective current	Default	150%
	Setting Range	100% ~ 200%	

When the output current exceeds the overcurrent stall protective current during acceleration/deceleration of the AC drive, the AC drive stops acceleration/deceleration and keeps the present running frequency. After the output current declines, the AC drive continues to accelerate/decelerate.

10.05 (Overcurrent stall gain) is used to adjust the overcurrent suppression capacity of the AC drive. The larger the value is, the greater the overcurrent suppression capacity will be. In the prerequisite of no overcurrent occurrence, set 10.05 to a small value.

For small-inertia load, the value should be small. Otherwise, the system dynamic response will be slow. For large-inertia load, the value should be large. Otherwise, the suppression result will be poor and overcurrent fault may occur.

If the overcurrent stall gain is set to 0, the overcurrent stall function is disabled.

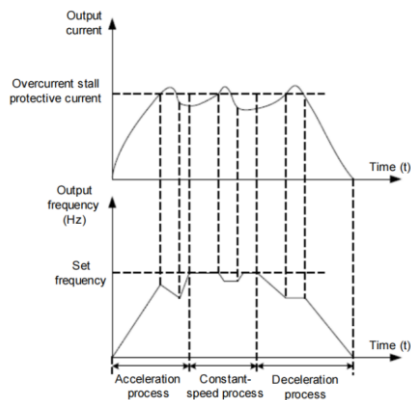

Overcurrent stall protection function

10.07	Short-circuit to ground upon power-on	Default	1
	Setting Range	0: Disabled; 1: Enabled	

It is used to determine whether to check the motor is short-circuited to ground at power-on of the AC drive. If this function is enabled, the AC drive's UVW will have voltage output a while after power-on.

10.08	Braking unit action starting voltage	Default	Model depended
	Setting Range	200.0~2000.0V	

The starting voltage V_{break} of the built-in braking unit action, the setting reference of this voltage value:
 $800 \geq V_{break} \geq (1.414V_s + 30)$

V_s —input AC supply voltage of inverter

Note: Improper setting of this voltage may cause the built-in braking unit to operate abnormally!

10.09	Fault auto reset times	Default	0
	Setting Range	0 ~ 20	

It is used to set the times of fault auto resets if this function is used. After the value is exceeded, the AC drive will remain in the fault state.

10.10	DO action during fault auto reset	Default	0
	Setting Range	0: Not act; 1: Act	

It is used to decide whether the DO acts during the fault auto reset if the fault auto reset function is selected.

10.11	Time interval of fault auto reset	Default	1.0s
	Setting Range	0.1s ~ 100.0	

It is used to set the waiting time from the alarm of the AC drive to fault auto reset.

10.12	Input phase loss protection/contactor energizing protection selection	Default	11
	Setting Range	Unit's digit: Input phase loss protection Ten's digit: Contactor energizing 0: Disabled 1: Enabled	

Select whether to protect input phase loss or contactor pull-in.

The three-phase 380v voltage level of the DSI-100 inverter is only 18.5kw and above has the function of input phase loss protection and contactor pull-in.

Below 18.5kw, no matter if 10.12 is set to 0 or 1, there is no input phase loss, contactor pull-in combined protection function.

10.13	Output phase loss protection selection	Default	1
	Setting Range	0: Disabled 1: Enabled	

Select whether to protect the output phase loss.

If you select 0 and the output phase loss actually occurs, no fault will be reported. At this time, the actual current is larger than the current displayed on the panel, and there is a risk. Use with caution.

10.14	1st fault type	0 ~ 99
10.15	2nd fault type	
10.16	3rd (latest) fault type	

It is used to record the types of the most recent three faults of the AC drive. 0 indicates no fault. For possible causes and solution of each fault, refer to alarm information for details.

10.17	Frequency upon 3rd fault	It displays the frequency when the latest fault occurs.																				
10.18	Current upon 3rd fault	It displays the current when the latest fault occurs.																				
10.19	Bus voltage upon 3rd fault	It displays the bus voltage when the latest fault occurs.																				
10.20	Digital Input status upon 3rd fault	<p>It displays the status of all DI terminals when the latest fault occurs. The sequence is as follows:</p> <table border="1" style="margin-left: auto; margin-right: auto;"> <tr> <td>BIT9</td><td>BIT8</td><td>BIT7</td><td>BIT6</td><td>BIT5</td><td>BIT4</td><td>BIT3</td><td>BIT2</td><td>BIT1</td><td>BIT0</td> </tr> <tr> <td>DI0</td><td>DI9</td><td>DI8</td><td>DI7</td><td>DI6</td><td>DI5</td><td>DI4</td><td>DI3</td><td>DI2</td><td>DI1</td> </tr> </table> <p>If the X terminal is ON, the setting is 1. If the X terminal is OFF, the setting is 0. The value is the equivalent decimal number converted from the X terminal status.</p>	BIT9	BIT8	BIT7	BIT6	BIT5	BIT4	BIT3	BIT2	BIT1	BIT0	DI0	DI9	DI8	DI7	DI6	DI5	DI4	DI3	DI2	DI1
BIT9	BIT8	BIT7	BIT6	BIT5	BIT4	BIT3	BIT2	BIT1	BIT0													
DI0	DI9	DI8	DI7	DI6	DI5	DI4	DI3	DI2	DI1													
10.21	Output terminal status upon 3rd fault	<p>It displays the status of all output terminals when the latest fault occurs. The sequence is as follows:</p> <table border="1" style="margin-left: auto; margin-right: auto;"> <tr> <td>BIT4</td><td>BIT3</td><td>BIT2</td><td>BIT1</td><td>BIT0</td> </tr> <tr> <td>DO2</td><td>DO1</td><td>REL2</td><td>REL1</td><td>FMP</td> </tr> </table> <p>If an output terminal is ON, the setting is 1. If the output terminal is OFF, the setting is 0. The value is the equivalent decimal number converted from the DO terminal statuses.</p>	BIT4	BIT3	BIT2	BIT1	BIT0	DO2	DO1	REL2	REL1	FMP										
BIT4	BIT3	BIT2	BIT1	BIT0																		
DO2	DO1	REL2	REL1	FMP																		
10.22	AC drive status upon 3 rd Fault	Reserved																				
10.23	Power-on time upon 3 rd Fault	It displays the present power-on time when the latest fault occurs.																				
10.24	Running time upon 3 rd Fault	It displays the present running time when the latest fault occurs.																				
10.27	Frequency upon 2nd fault	Same as 10.17~10.24																				
10.28	Current upon 2nd fault																					
10.29	Bus voltage upon 2nd fault																					
10.30	Second fault input terminal																					
10.31	Second fault output terminal																					
10.32	Second fault inverter state																					
10.33	Second fault power-on time																					
10.34	Second fault running time																					

10.37	First fault frequency	Same as 10.17~10.24
10.38	First fault current	
10.39	First fault bus voltage	
10.40	First fault input terminal	
10.41	First fault output terminal	
10.42	First fault inverter state	
10.43	First fault power-on time	
10.44	First fault running time	

10.47	Fault protection action selection 1		Default	00000
	Setting Range	Unit's digit	Motor overload (Err11)	
		0	Coast to stop	
		1	Stop according to the stop mode	
		2	Continue to run	
		Ten's digit	Power input phase loss (Err12)	
		Hundred's digit	Power output phase loss (Err13)	
		Thousand's digit	External equipment fault (Err15)	
Ten thousand's digit		Communication fault (Err16) (Same as unit's digit)		
10.48	Fault protection action selection 2		Default	00000
	Setting Range	Unit's digit	Encoder fault (Err20)	
		0	Coast to stop	
		1	Switch over to V/F control, stop according to the	
		2	Switch over to V/F control, continue to run	
		Ten's digit	EEPROM read-write fault (Err21)	
		0	Coast to stop	
		1	Stop according to the stop mode	
		Hundred's digit	Reserved	
		Thousand's digit	Motor overheat (Err25) (Same as unit's digit in	
Ten thousand's digit		Accumulative running time reached (Err26) (Same as unit's digit in 10.47)		
10.49	Fault protection action selection 3		Default	00000
	Setting Range	Unit's digit	User-defined fault 1 (Err27) Same as unit's digit in 10.-47	
		Ten's digit	User-defined fault 2 (Err28) Same as unit's digit in 10.-47	

		Hundred's digit	Accumulative power-on time reached (Err29) Same as unit's digit in 10.-47
		Thousand's digit	Load becoming 0 (Err30)
		0	Coast to stop
		1	Stop according to the stop mode
		2	Continue to run at 7% of rated motor frequency and resume to the set frequency if the load Recovers
		Ten thousand's digit	PID feedback lost during running (Err31) Same as unit's digit in 10.-47
	Fault protection action selection 4	Default	00000
10.50	Setting Range	Unit's digit	Too large speed deviation, (Err42) Same as unit's digit in 10.47
		Ten's digit	Motor over-speed (Err43) Same as unit's digit in 10.47
		Hundred's digit	Initial position fault (Err51) Same as unit's digit in 10.47
		Thousand's digit	Speed feedback fault (Err52) Same as unit's digit in 10.47
		Ten thousand's digit	Reserved

- If "Coast to stop" is selected, the AC drive displays Err** and directly stops.
- If "Stop according to the stop mode" is selected, the AC drive displays A** and stops according to the stop mode. After stop, the AC drive displays Err**.
- If "Continue to run" is selected, the AC drive continues to run and displays A**. The running frequency is set in 10.54.

10.54	Frequency selection for continuing to run upon fault		Default	0
	Setting Range	0	Current running frequency	
		1	Set frequency	
		2	Frequency upper limit	
		3	Frequency lower limit	
		4	Backup frequency upon abnormality	
10.55	Backup frequency upon abnormality		Default	100.0%
	Setting Range		0.0% ~ 100.0%(maximum frequency)	

If a fault occurs during the running of the AC drive and the handling of fault is set to "Continue to run", the AC drive displays A** and continues to run at the frequency set in 10.54. The setting of 10.55 is a percentage relative to the maximum frequency.

10.59	Action selection at instantaneous power failure		Default	0
	Setting Range	0	Invalid	
		1	Decelerate	
2	Decelerate to stop			
10.60	Action pause judging voltage at instantaneous power failure		Default	90.0%
	Setting Range		80.0% ~100.0%	
10.61	Voltage rally judging time at instantaneous power failure		Default	0.50s
	Setting Range		0.00s ~100.00s	
10.62	Action judging voltage at instantaneous power failure		Default	80.0%
	Setting Range		60.0% ~100.0%(standard bus voltage)	

Upon instantaneous power failure or sudden voltage dip, the DC bus voltage of the AC drive reduces. This function enables the AC drive to compensate the DC bus voltage reduction with the load feedback energy by reducing the output frequency so as to keep the AC drive running continuously.

- If 10.59 = 1, upon instantaneous power failure or sudden voltage dip, the AC drive decelerates. Once the bus voltage resumes to normal, the AC drive accelerates to the set frequency. If the bus voltage remains normal for the time exceeding the value set in 10.61, it is considered that the bus voltage resumes to normal.
- If 10.59 = 2, upon instantaneous power failure or sudden voltage dip, the AC drive decelerates to stop.

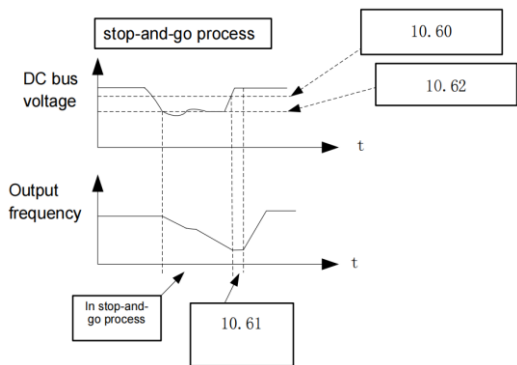

AC drive action diagram upon instantaneous power failure

Remark:

(1) In the case of constant bus voltage control, when the power grid is restored, the output frequency of the inverter will continue to run to the target frequency. In deceleration stop mode, when the power grid is restored, the inverter will continue to decelerate to 0Hz and stop until the inverter sends a start command again. .

(2) The purpose of non-stop instantaneous power failure is to ensure that when the power supply of the grid is abnormal, the motor can decelerate and stop normally, so that after the power grid returns to normal power supply, the motor can be started immediately, and the motor will not suddenly owe when the power supply of the grid is abnormal. In the large inertia system, it takes a long time for the motor to coast to stop. When the power supply is normal, since the motor is still rotating at a high speed, starting the motor at this time will easily cause the inverter to generate an overload or overcurrent fault.

10.63	Protection upon load becoming 0		Default	0
	Setting Range	0	Disabled	
		1	Enabled	
10.64	Detection level of load becoming 0		Default	10.0%
	Setting Range		0.0% ~ 100.0% (rated motor current)	
10.65	Detection time of load becoming 0		Default	1.0s
	Setting Range		0.0s ~ 60.0s	

If protection upon load becoming 0 is enabled, when the output current of the AC drive is lower than the detection level (10.64) and the lasting time exceeds the detection time (10.65), the output frequency of the AC drive automatically declines to 7% of the rated frequency. During the protection, the AC drive automatically accelerates to the set frequency if the load resumes to normal.

10.67	Over-speed detection value		Default	20.0%
	Setting Range		0.0% ~ 50.0% (maximum frequency)	
10.68	Over-speed detection time		Default	1.0s
	Setting Range		0.0s ~ 60.0s	

This function is valid only when the AC drive runs in the CLVC mode. If the actual motor rotational speed detected by the AC drive exceeds the maximum frequency and the excessive value is greater than the value of 10.67 and the lasting time exceeds the value of 10.68, the AC drive reports Err43 and acts according to the selected fault protection action.

If the over-speed detection time is 0.0s, the over-speed detection function is disabled.

Group 11 Process Control PID Functions

PID control is a general process control method. By performing proportional, integral and differential operations on the difference between the feedback signal and the target signal, it adjusts the output frequency and constitutes a feedback system to stabilize the controlled counter around the target value.

It is applied to process control such as flow control, pressure control and temperature control. The following figure shows the principle block diagram of PID control.

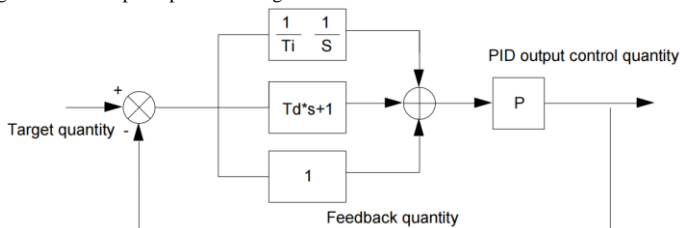

Principle block diagram of PID control

11.00	PID setting source		Default	0
	Setting Range	0	11.01 Setting	
		1	AI1	
		2	AI2	
		3	AI3 (Keyboard Potentiometer)	
		4	PULSE Pulse (DI5)	
		5	Communication	
		6	Multi-reference	

11.01	PID digital setting	Default	50.0%
	Setting range	0.0% ~ 100.0%	

11.00 is used to select the channel of target process PID setting. The PID setting is a relative value and ranges from 0.0% to 100.0%. The PID feedback is also a relative value.

The purpose of PID control is to make the PID setting and PID feedback equal.

11.02	PID Feedback source		Default	0
	Setting range	0	AI1	
		1	AI2	
		2	AI3 (Keyboard Potentiometer)	
		3	AI1-AI2	
		4	PULSE Pulse (DI5)	
		5	Communication	
		6	AI1+AI2	
		7	MAX(AI1 , AI2)	
8	MIN (AI1 , AI2)			

This parameter is used to select the feedback signal channel of process PID.

The PID feedback is a relative value and ranges from 0.0% to 100.0%.

11.03	PID action direction		Default	0
	Setting range	0	Positive effect	
		1	Negative effects	

0: Forward action

When the feedback value is smaller than the PID setting, the AC drive's output frequency rises. For example, the winding tension control requires forward PID action.

1: Reverse action

When the feedback value is smaller than the PID setting, the AC drive's output frequency reduces. For example, the unwinding tension control requires reverse PID action.

Note that this function is influenced by the DI function 35 "Reverse PID action direction".

11.04	PID setting feedback range	Default	1000
	Setting range	0 ~ 65535	

This parameter is a non-dimensional unit. It is used for PID setting display (00.15) and PID feedback display (00.16). Relative value 100% of PID setting feedback corresponds to the value of 11.04. If 11.04 is set to 2000 and PID setting is 100.0%, the PID setting display (00.15) is 2000.PID

11.05	Proportional gain Kp1	Default	20.0
	Setting range	0.0 ~ 100.0	
11.06	Integral time Ti1	Default	2.00s
	Setting range	0.01s ~ 10.00s	
11.07	Differential timeTd1	Default	0.000s
	Setting range	0.00 ~ 10.000	

- 11.05 (Proportional gain Kp1)

It decides the regulating intensity of the PID regulator. The higher the Kp1 is, the larger the regulating intensity is. The value 100.0 indicates when the deviation between PID feedback and PID setting is 100.0%, the adjustment amplitude of the PID regulator on the output frequency reference is the maximum frequency.

- 11.06 (Integral time Ti1)

It decides the integral regulating intensity. The shorter the integral time is, the larger the regulating intensity is. When the deviation between PID feedback and PID setting is 100.0%, the integral regulator performs continuous adjustment for the time set in 11.06. Then the adjustment amplitude reaches the maximum frequency.

- 11.07 (Differential time Td1)

It decides the regulating intensity of the PID regulator on the deviation change. The longer the differential time is, the larger the regulating intensity is. Differential time is the time within which the feedback value change reaches 100.0%, and then the adjustment amplitude reaches the maximum frequency.

11.08	Cut-off frequency of PID reverse rotation	Default	2.00Hz
	Setting range	0.00 ~Max frequency	

In some cases, only when the PID output frequency is negative (that is, the inverter is reversed), can the PID control the given amount and the feedback amount to the same state, but too high reverse frequency is not allowed in some occasions, 11.08 is used to determine the upper limit of the reverse frequency.

When the frequency source is PID, the upper and lower limits and the range of frequency output:

For example: frequency source is pure PID or main + PID

1) The inversion cut-off frequency is 0 or the inversion is prohibited (that is, any of the following three)

(1) 11.08=0, 09.13=0;

(2) 11.08=0, 09.13=1;

(3) 11.08=0, 09.13=1

Output upper limit: upper limit frequency

Output lower limit: lower limit frequency

Output range: lower limit frequency ~ upper limit frequency (ie 01.14 ~ 01.12)

2) Inversion cut-off frequency is not 0 and inversion is not prohibited (ie 11.08=0, 09.13=0)

Output upper limit: upper limit frequency

Output lower limit: Invert cutoff frequency

Output range: reverse cutoff frequency ~ upper limit frequency

11.09	PID deviation limit	Default	0.0%
	Setting range	0. 0% ~100.0%	

If the deviation between PID feedback and PID setting is smaller than the value of 11.09, PID control stops. The small deviation between PID feedback and PID setting will make the output frequency stabilize, effective for some closed-loop control applications.

11.10	PID deviation limit	Default	0.10%
	Setting range	0. 00% ~100.00%	

It is used to set the PID differential output range. In PID control, the differential operation may easily cause system oscillation. Thus, the PID differential regulation is restricted to a small range.

11.11	PID setting change time	Default	0.00s
	Setting range	0.00s ~650.00s	

The PID setting change time indicates the time required for PID setting changing from 0.0% to 100.0%.

The PID setting changes linearly according to the change time, reducing the impact caused by sudden setting change on the system.

11.12	PID feedback filter time	Default	0.00s
	Setting range	0.00s ~ 60.00s	
11.13	PID output filter time	Default	0.00s
	Setting range	0.00s ~ 60.00s	

11.12 is used to filter the PID feedback, helping to reduce interference on the feedback but slowing the response of the process closed-loop system.

11.13 is used to filter the PID output frequency, helping to weaken sudden change of the AC drive output frequency but slowing the response of the process closed-loop system.

11.15	Proportional gain Kp2		Default	20.0
	Setting range		0.0 ~ 100.0	
11.16	Integral time Ti2		Default	2.00s
	Setting range		0.01s ~ 10.00s	
11.17	Differential time Td2		Default	0.000s
	Setting range		0.00 ~ 10.000	
11.18	PID parameter switchover condition		Default	0
	Setting range	0	No switchover	
		1	Switchover via DI	
		2	Automatic switchover based on deviation	
11.19	PID parameter switchover deviation 1		Default	20.0%
	Setting range		0.0% ~ 11.20	
11.20	PID parameter switchover deviation 2		Default	80.0%
	Setting range		11.19 ~ 100.0%	

In some applications, PID parameters switchover is required when one group of PID parameters cannot satisfy the requirement of the whole running process.

These parameters are used for switchover between two groups of PID parameters. Regulator parameters 11.15 to 11.17 are set in the same way as 11.05 to 11.07.

The switchover can be implemented either via a DI terminal or automatically implemented based on the deviation.

If you select switchover via a DI terminal, the DI must be allocated with function 43 "PID parameter switchover". If the DI is OFF, group 1 (11.05 to 11.07) is selected. If the DI is ON, group 2 (11.15 to 11.17) is selected.

If you select automatic switchover, when the absolute value of the deviation between PID feedback and PID setting is smaller than the value of 11.19, group 1 is selected. When the absolute value of the deviation between PID feedback and PID setting is higher than the value of 11.20, group 2 is selected. When the deviation is between 11.19 and 11.20, the PID parameters are the linear interpolated value of the two groups of parameter values.

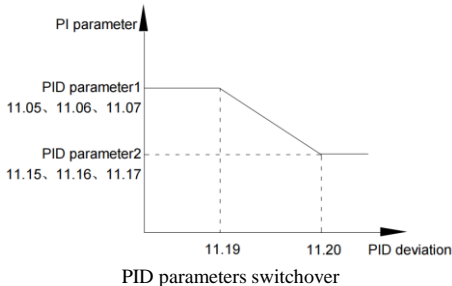

11.21	PID initial value	Default	0.0%
	Setting range	0.0% ~ 100.0%	
11.22	PID initial value holding time	Default	0.00s
	Setting range	0.00s ~ 650.00s	

When the inverter starts, the PID output is fixed at the PID initial value of 11.21, and the PID starts the closed-loop adjustment operation after the PID initial value hold time of 11.22. Figure 6-36 is a functional schematic diagram of PID initial value.

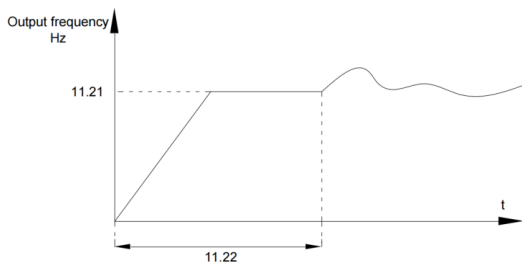

PID initial value function

11.25	PID integral property		Default	00
	Setting range	Unit's digit	Integral separated	
		0	Invalid	
		1	Valid	
		Ten's digit	Whether to stop integral operation when the output reaches the limit	
		0	Continue integral operation	
1	Stop integral operation			

- Integral separated

If it is set to valid, , the PID integral operation stops when the DI allocated with function 38 "PID integral pause" is ON In this case, only proportional and differential operations take effect.

If it is set to invalid, integral separated remains invalid no matter whether the DI allocated with function 38 "PID integral pause" is ON or not.

- Whether to stop integral operation when the output reaches the limit

If "Stop integral operation" is selected, the PID integral operation stops, which may help to reduce the PID overshoot.

11.26	Detection value of PID feedback loss	Default	0.0%
	Setting range	0.0%: Not judging feedback loss;	
11.27	Detection time of PID feedback loss	Default	0.0s
	Setting range	0.0s ~ 20.0s	

These parameters are used to judge whether PID feedback is lost.

If the PID feedback is smaller than the value of 11.26 and the lasting time exceeds the value of 11.27, the AC drive reports Err31 and acts according to the selected fault protection action.

11.28	PID operation at stop		Default	0
	Setting range	0	No PID operation at stop	
		1	PID operation at stop	

It is used to select whether to continue PID operation in the state of stop. Generally, the PID operation stops when the AC drive stops.

Group 12: Swing Frequency, Fixed Length and Count

The swing frequency function is applied to the textile and chemical fiber fields and the applications where traversing and winding functions are required.

The swing frequency function indicates that the output frequency of the AC drive swings up and down with the set frequency as the center. The trace of running frequency at the time axis is shown in the following figure.

The swing amplitude is set in 12.00 and 12.01. When 12.01 is set to 0, the swing amplitude is 0 and the swing frequency does not take effect.

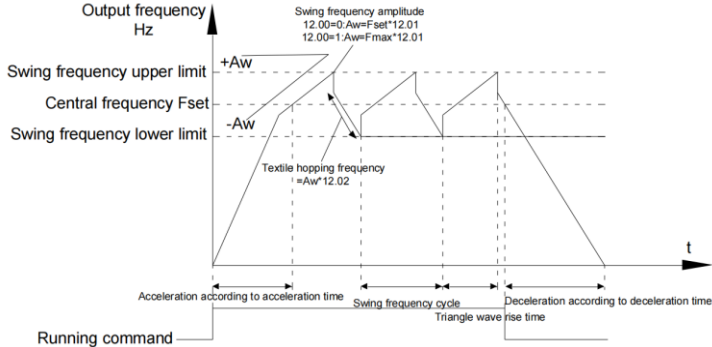

Schematic diagram of swing frequency operation

12.00	Swing frequency setting mode		Default	0
	Setting range	0	Relative to the central frequency	
		1	Relative to the maximum frequency	

This parameter is used to select the base value of the swing amplitude.

- 0: Relative to the central frequency (01.07 frequency source selection)

It is variable swing amplitude system. The swing amplitude varies with the central frequency (set frequency).

- 1: Relative to the maximum frequency (01.10 maximum output frequency)

It is fixed swing amplitude system. The swing amplitude is fixed.

12.01	Swing frequency amplitude	Default	0.0%
	Setting range	0.0% ~ 100.0%	
12.02	Jump frequency amplitude	Default	0.0%
	Setting range	0.0% ~ 50.0%	

This parameter is used to determine the swing amplitude and jump frequency amplitude.

The swing frequency is limited by the frequency upper limit and frequency lower limit.

- If relative to the central frequency (12.00 = 0), the actual swing amplitude AW is the calculation result of 01.07 (Frequency source selection) multiplied by 12.01.

- If relative to the maximum frequency (12.00 = 1), the actual swing amplitude AW is the calculation result of 01.10 (Maximum frequency) multiplied by 12.01.

Jump frequency = Swing amplitude AW x 12.02 (Jump frequency amplitude).

- If relative to the central frequency (12.00 = 0), the jump frequency is a variable value.
- If relative to the maximum frequency (12.00 = 1), the jump frequency is a fixed value.

The swing frequency is limited by the frequency upper limit and frequency lower limit.

12.03	Swing frequency cycle	Default	10.0s
	Setting range	0.0s ~ 3000.0s	
12.04	Triangular wave rising time coefficient	Default	50.0%
	Setting range	0.0% ~ 100.0%	

12.03 specifies the time of a complete swing frequency cycle.

12.04 specifies the time percentage of triangular wave rising time to 12.03 (Swing frequency cycle).

- Triangular wave rising time = 12.03 (Swing frequency cycle) x 12.04 (Triangular wave rising time coefficient, unit: s)
- Triangular wave falling time = 12.03 (Swing frequency cycle) x (1 - 12.04 Triangular wave rising time coefficient, unit: s)

12.05	Setting Length	Default	1000m
	Setting range	0m ~ 65535m	
12.06	Actual Length	Default	0m
	Setting range	0m ~ 65535m	
12.07	Pulse/meter	Default	100.0
	Setting range	0.1 ~ 6553.5	

The preceding parameters are used for fixed length control.

The length information is collected by DI terminals. 12.06 (Actual length) is calculated by dividing the number of pulses collected by the DI terminal by 12.07 (Number of pulses each meter).

When the actual length 12.06 exceeds the set length in 12.05, the DO terminal allocated with function 10 (Length reached) becomes ON.

During the fixed length control, the length reset operation can be performed via the DI terminal allocated with function 28. For details, see the descriptions of P4-00 to P4-09.

Allocate corresponding DI terminal with function 27 (Length count input) in applications. If the pulse frequency is high, DI5 must be used.

12.08	Set count value	Default	1000
	Setting range	1 ~ 65535	
12.09	Designated count value	Default	1000
	Setting range	1 ~ 65535	

The count value needs to be collected by DI terminal. Allocate the corresponding DI terminal with function 25 (Counter input) in applications. If the pulse frequency is high, DI5 must be used.

When the count value reaches the set count value (12.08), the DO terminal allocated with function 8 (Set count value reached) becomes ON. Then the counter stops counting.

When the counting value reaches the designated counting value (12.09), the DO terminal allocated with function 9 (Designated count value reached) becomes ON. Then the counter continues to count until the set count value is reached.

12.09 should be equal to or smaller than 12.08.

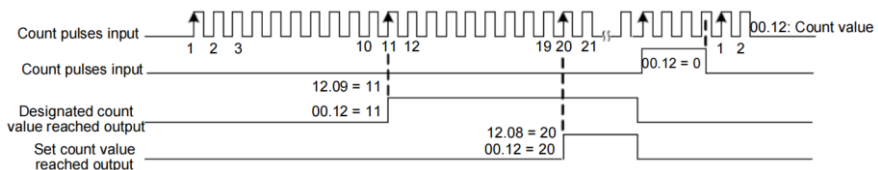

Reaching the set count value and designated count value

Group13 Multi-stage speed command and simple PLC function

The multi-stage speed command of DSI-100 has more functions than the usual multi-stage speed. In addition to realizing the multi-stage speed function, it can also be used as a voltage source for VF separation and a given source for process PID. For this reason, the dimensions of multi-segment instructions are relative.

The simple PLC function is different from the user programmable function of DSI-100. Simple PLC can only complete the simple combined operation of multi-segment instructions.

13.00	Multi-reference 0	Default	0.0%
	Setting range	-100.0% ~ 100.0%	
13.01	Multi-reference 1	Default	0.0%
	Setting range	-100.0% ~ 100.0%	
13.02	Multi-reference 2	Default	0.0%
	Setting range	-100.0% ~ 100.0%	
13.03	Multi-reference 3	Default	0.0%
	Setting range	-100.0% ~ 100.0%	
13.04	Multi-reference 4	Default	0.0%
	Setting range	-100.0% ~ 100.0%	
13.05	Multi-reference 5	Default	0.0%
	Setting range	-100.0% ~ 100.0%	
13.06	Multi-reference 6	Default	0.0%
	Setting range	-100.0% ~ 100.0%	
13.07	Multi-reference 7	Default	0.0%
	Setting range	-100.0% ~ 100.0%	
13.08	Multi-reference 8	Default	0.0%
	Setting range	-100.0% ~ 100.0%	
13.09	Multi-reference 9	Default	0.0%
	Setting range	-100.0% ~ 100.0%	
13.10	Multi-reference 10	Default	0.0Hz
	Setting range	-100.0% ~ 100.0%	
13.11	Multi-reference 11	Default	0.0%
	Setting range	-100.0% ~ 100.0%	
13.12	Multi-reference 12	Default	0.0%
	Setting range	-100.0% ~ 100.0%	
13.13	Multi-reference 13	Default	0.0%
	Setting range	-100.0% ~ 100.0%	
13.14	Multi-reference 14	Default	0.0%
	Setting range	-100.0% ~ 100.0%	
13.15	Multi-reference 15	Default	0.0%
	Setting range	-100.0% ~ 100.0%	

Multi-reference can be the setting source of frequency, V/F separated voltage and process PID. The multi-reference is relative value and ranges from -100.0% to 100.0%.

As frequency source, it is a percentage relative to the maximum frequency.

As V/F separated voltage source, it is a percentage relative to the rated motor voltage. As process PID

setting source, it does not require conversion.

Multi-reference can be switched over based on different states of DI terminals. For details, see the descriptions of group 05.

13.16	Simple PLC running mode		Default	0
	Setting range	0	Stop after the AC drive runs one cycle	
		1	Keep final values after the AC drive runs	
		2	Repeat after the AC drive runs one cycle	

The AC drive stops after running one cycle, and will not start up until receiving another command.

- 1: Keep final values after the AC drive runs one cycle

The AC drive keeps the final running frequency and direction after running one cycle.

- 2: Repeat after the AC drive runs one cycle

The AC drive automatically starts another cycle after running one cycle, and will not stop until receiving the stop command.

Simple PLC can be either the frequency source or V/F separated voltage source.

When simple PLC is used as the frequency source, whether parameter values of 13.00 to 13.15 are positive or negative determines the running direction. If the parameter values are negative, it indicates that the AC drive runs in reverse direction.

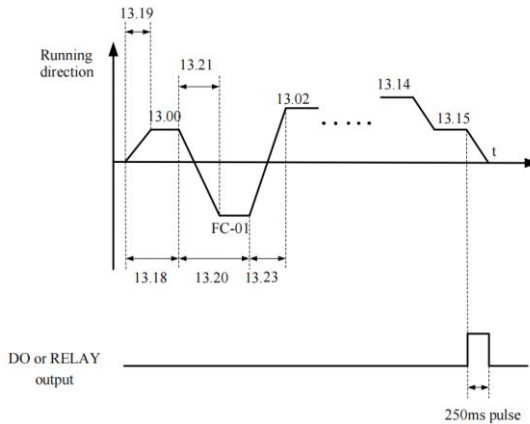

Simple PLC when used as frequency source

13.17	Simple PLC retentive selection		Default	00
	Setting range	Unit's digit	Retentive upon power failure	
		0	No	
		1	Yes	
		Ten's digit	Retentive upon stop	
		0	No	
1		Yes		

PLC retentive upon power failure indicates that the AC drive memorizes the PLC running moment and running frequency before power failure and will continue to run from the memorized moment after it is powered on again. If the unit's digit is set to 0, the AC drive restarts the PLC process after it is powered on again.

PLC retentive upon stop indicates that the AC drive records the PLC running moment and running frequency upon stop and will continue to run from the recorded moment after it starts up again. If the ten's digit is set to 0, the AC drive restarts the PLC process after it starts up again.

13.18	Running time of simple PLC reference 0	Default	0.0s(h)
	Setting range	0.0s(h) ~ 6553.5s(h)	
13.19	Acceleration/deceleration time of simple PLC reference 0	Default	0
	Setting range	0 ~ 3	
13.20	Running time of simple PLC reference 1	Default	0.0s(h)
	Setting range	0.0s(h) ~ 6553.5s(h)	
13.21	Acceleration/deceleration time of simple PLC reference 1	Default	0
	Setting range	0 ~ 3	
13.22	Running time of simple PLC reference 2	Default	0.0s(h)
	Setting range	0.0s(h) ~ 6553.5s(h)	
13.23	Acceleration/deceleration time of simple PLC reference 2	Default	0
	Setting range	0 ~ 3	
13.24	Running time of simple PLC reference 3	Default	0.0s(h)
	Setting range	0.0s(h) ~ 6553.5s(h)	
13.25	Acceleration/deceleration time of simple PLC reference 3	Default	0
	Setting range	0 ~ 3	
13.26	Running time of simple PLC reference 4	Default	0.0s(h)
	Setting range	0.0s(h) ~ 6553.5s(h)	
13.27	Acceleration/deceleration time of simple PLC reference 4	Default	0
	Setting range	0 ~ 3	
13.28	Running time of simple PLC reference 5	Default	0.0s(h)
	Setting range	0.0s(h) ~ 6553.5s(h)	
13.29	Acceleration/deceleration time of simple PLC reference 5	Default	0
	Setting range	0 ~ 3	
13.30	Running time of simple PLC reference 6	Default	0.0s(h)
	Setting range	0.0s(h) ~ 6553.5s(h)	
13.31	Acceleration/deceleration time of simple PLC reference 6	Default	0
	Setting range	0 ~ 3	
13.32	Running time of simple PLC reference 7	Default	0.0s(h)
	Setting range	0.0s(h) ~ 6553.5s(h)	
13.33	Acceleration/deceleration time of simple PLC reference 7	Default	0
	Setting range	0 ~ 3	
13.34	Running time of simple PLC reference 8	Default	0.0s(h)
	Setting range	0.0s(h) ~ 6553.5s(h)	
13.35	Acceleration/deceleration time of simple PLC reference 8	Default	0
	Setting range	0 ~ 3	
13.36	Running time of simple PLC reference 9	Default	0.0s(h)
	Setting range	0.0s(h) ~ 6553.5s(h)	
13.37	Acceleration/deceleration time of simple PLC reference 9	Default	0
	Setting range	0 ~ 3	

13.38	Running time of simple PLC reference 10	Default	0.0s(h)
	Setting range	0.0 s(h) ~ 6553.5s(h)	
13.39	Acceleration/deceleration time of simple PLC reference 10	Default	0
	Setting range	0 ~ 3	
13.40	Running time of simple PLC reference 11	Default	0.0s(h)
	Setting range	0.0s(h) ~ 6553.5s(h)	
13.41	Acceleration/deceleration time of simple PLC reference 11	Default	0
	Setting range	0 ~ 3	
13.42	Running time of simple PLC reference 12	Default	0.0s(h)
	Setting range	0.0s(h) ~ 6553.5s(h)	
13.43	Acceleration/deceleration time of simple PLC reference 12	Default	0
	Setting range	0 ~ 3	
13.44	Running time of simple PLC reference 13	Default	0.0s(h)
	Setting range	0.0s(h) ~ 6553.5s(h)	
13.45	Acceleration/deceleration time of simple PLC reference 13	Default	0
	Setting range	0 ~ 3	
13.46	Running time of simple PLC reference 14	Default	0.0s(h)
	Setting range	0.0s(h) ~ 6553.5s(h)	
13.47	Acceleration/deceleration time of simple PLC reference 14	Default	0
	Setting range	0 ~ 3	
13.48	Running time of simple PLC reference 15	Default	0.0s(h)
	Setting range	0.0s(h) ~ 6553.5s(h)	
13.49	Acceleration/deceleration time of simple PLC reference 15	Default	0
	Setting range	0 ~ 3	
13.50	Time unit of simple PLC running	Default	0
	Setting range	0	S (Second)
		1	H (Hours)

13.51	Reference	0	Default	0
	Setting range	0	Set by 13.00	
		1	AI1	
		2	AI2	
		3	AI3 (Keyboard Potentiometer)	
		4	PULSE	
		5	PID	
		6	Set by preset frequency (01.08), modified via terminal UP/DOWN	

It determines the setting channel of reference 0. You can perform convenient switchover between the setting channels. When multi-reference or simple PLC is used as frequency source, the switchover between two frequency sources can be realized easily.

Group14 Communication parameters

Please refer to "DSI-100 Communication Protocol"

Group 17 User Password

17.00	User's password	Default	0
	Setting range	0 ~ 65535	

If it is set to any non-zero number, the password protection function is enabled. After a password has been set and taken effect, you must enter the correct password in order to enter the menu. If the entered password is incorrect you cannot view or modify parameters.

If 17.00 is set to 00000, the previously set user password is cleared, and the password protection function is disabled.

17.01	Restore default	Default	0
	Setting range	0	No option settings
		1	Restore factory settings except motor parameters
		2	Clear records

1: Restore the factory setting, excluding motor parameters

After setting 17.01 to 1, most of the functional parameters of the inverter are restored to the factory default parameters, but the motor parameters, frequency command decimal point (01.22), fault record information, cumulative running time (08.09), cumulative power-on time (08.13), cumulative Power consumption (08.14) is not restored.

2: Clear record information

Clear the inverter fault record information, cumulative running time (08.09), cumulative power-on time (08.13), and cumulative power consumption (08.14).

17.02	AC drive parameter display property		Default	11
	Setting range	Unit's digit	Group U display selection	
		0	No display	
		1	Display	
		Ten's digit	Group A display selection	
		0	No display	
1		Display		
17.03	Individualized parameter display property		Default	00
	Setting range	Unit's digit	User-defined parameter display selection	
		0	No display	
		1	Display	
		Ten's digit	User-modified parameter display selection	
		0	No display	
1		Display		

The setting of parameter display mode aims to facilitate you to view different types of parameters based on actual requirements. The DSI-100 provides the following three parameter display modes.

Parameter Name	Description
AC drive parameter display	Display function codes of the AC drive in sequence of 01 to 16, 18 to 33 and 00 Group.
User-defined parameter display	Display a maximum of 32 user-defined parameters included in group 15.
User-modified parameter display	Display the parameters that are modified.

If one digit of 17.03 is set to 1, you can switch over to different parameter display modes by pressing key QUICK. By default, the AC drive parameter display mode is used.

The display codes of different parameter types are shown in the following table.

Parameter Display Mode	Display
AC drive parameter	-BASE
User-defined parameter	-USER
User-modified parameter	--[- -

The DSI-100 provides display of two types of individualized parameters: user-defined parameters and user-modified parameters.

- You-defined parameters are included in group PE. You can add a maximum of 32 parameters, convenient for commissioning.

In user-defined parameter mode, symbol "u" is added before the function code. For example, 02.00 is displayed as u02.00.

- You-modified parameters are grouped together, convenient for on-site troubleshooting.

In you-modified parameter mode, symbol "c" is added before the function code. For example, 02.00 is displayed as c02.00.

17.04	Parameter modification property	Default	0
	Setting range	0	Modifiable
		1	Not modifiable

It is used to set whether the parameters are modifiable to avoid mal-function. If it is set to 0, all parameters are modifiable. If it is set to 1, all parameters can only be viewed.

Group18~22 Reserved

Group 23 Control optimization parameters

23.00	DPWM switching upper	Default	8Hz
	Setting range	5.00Hz~Max. frequency	

This parameter is valid only for V/F control.

It is used to determine the wave modulation mode in V/F control of asynchronous motor.

If the frequency is lower than the value of this parameter, the waveform is 7-segment continuous modulation.

If the frequency is higher than the value of this parameter, the waveform is 5-segment intermittent modulation.

The 7-segment continuous modulation causes more loss to switches of the AC drive but smaller current ripple.

The 5-segment intermittent modulation causes less loss to switches of the AC drive but larger current ripple.

This may lead to motor running instability at high frequency. Do not modify this parameter generally.

For instability of V/F control, refer to parameter 04.11. For loss to AC drive and temperature rise, refer to parameter 01.15.

23.01	PWM modulation mode		Default	0
	Setting range	0	Asynchronous modulation	
		1	Synchronous modulation	

This parameter is valid only for V/F control.

Synchronous modulation indicates that the carrier frequency varies linearly with the change of the output frequency, ensuring that the ratio of carrier frequency to output frequency remains unchanged. Synchronous modulation is generally used at high output frequency, which helps improve the output voltage quality.

At low output frequency (100 Hz or lower), synchronous modulation is not required. This is because asynchronous modulation is preferred when the ratio of carrier frequency to output frequency is high. Synchronous modulation takes effect only when the running frequency is higher than 85 Hz. If the frequency is lower than 85 Hz, asynchronous modulation is always used.

23.02	Dead-zone compensation mode		Default	1
	Setting range	0	No compensation	
		1	Compensation mode 1	

Generally, you need not modify this parameter. Try to use a different compensation mode only when there is special requirement on the output voltage waveform quality or oscillation occurs on the motor. For high power AC drive, compensation mode 2 is recommended.

23.03	Random PWM depth		Default	0
	Setting range	0	Random PWM invalid	
		1~10	PWM carrier frequency random depth	

The setting of random PWM depth can make the shrill motor noise softer and reduce the electromagnetic interference. If this parameter is set to 0, random PWM is invalid.

23.04	Rapid current-limiting enable		Default	1
	Setting range	0	Disabled	
		1	Enabled	

The rapid current limit function can reduce the AC drive's overcurrent faults at maximum, guaranteeing uninterrupted running of the AC drive.

However, long-time rapid current limit may cause the AC drive to overheat, which is not allowed. In this case, the AC drive will report Err40, indicating the AC drive is overloaded and needs to stop.

23.05	Current detection compensation	Default	5
	Setting range	0~100	

It is used to set the AC drive current detection compensation. Too large value may lead to deterioration of control performance. Do not modify it generally

23.06	Under-voltage point setup	Default	Model depended
	Setting range	200.0V~2000.0V	

It is used to set the voltage value of the inverter undervoltage fault Err09 fault. The factory default value is related to the model.

Voltage Class	Nominal Value of Undervoltage threshold
Single-phase 220 V	200 V
Three-phase 220 V	200 V
Three-phase 380 V	350 V
Three-phase 480 V	450 V
Three-phase 690 V	650 V

23.09	Over-voltage point setup	Default	Model depended
	Setting range	200.0V~2500.0V	

It is used to set the overvoltage threshold of the AC drive. The default values of different voltage classes are listed in the following table.

Voltage Class	Default Overvoltage Threshold
Single-phase 220 V	400.0 V
Three-phase 220 V	400.0 V
Three-phase 380 V	810.0 V
Three-phase 480 V	890.0 V
Three-phase 690 V	1300.0 V

Overvoltage thresholds for different voltage classes

Note: The default value is also the upper limit of the inverter's internal overvoltage protection. This parameter setting takes effect only when the set value of 23.09 is less than the ex-factory value of each voltage level. When it is higher than the factory value, the factory value shall prevail.

Chapter 7 Fault Display and settlement

7.1 Guidance on the adjustment of the inverter before commissioning

1) Drive in Open-loop Vector Control (01.01=0)

The AC drive implements control of the motor speed and torque without an encoder for speed feedback. In this control mode, motor auto-tuning is required to obtain the motor related

Error	Solution
Overload or Over current detected during motor start	<ul style="list-style-type: none"> ◆ Set motor parameters (02.01~02.05) according to motor nameplate. ◆ Select a proper motor auto-tuning mode by setting 02.37 and perform motor auto-tuning. If possible, select dynamic auto-tuning
Poor torque or speed response and motor oscillation at speeds below 5 Hz	<ul style="list-style-type: none"> ◆ 1. If motor torque and speed response are too slow, increase the setting of 03.00 (speed loop proportional gain 1) by 10 gradually or decrease the setting of 03.01 (speed loop integral time 1) by 0.05 gradually. ◆ 2. If motor oscillation occurs, decrease the setting of 03.00 and 03.01.
Poor torque or speed response and motor oscillation at speeds above 5 Hz	<ul style="list-style-type: none"> ◆ 1. If motor torque and speed response are too slow, increase the setting of 03.03 (speed loop proportional gain 2) by 10 gradually or decrease the setting of 03.04 (speed loop integral time 4) by 0.05 gradually. ◆ 2. If motor oscillation occurs, decrease the setting of 03.03 and 03.04.
Low speed accuracy	<ul style="list-style-type: none"> ◆ If speed error when motor runs with load is large, increase the setting of 03.06 (vector control slip compensation gain) by 10% gradually.
Obvious speed fluctuation	<ul style="list-style-type: none"> ◆ If motor speed fluctuation is large, increase the setting of 03.07 (SVC torque filter time) by 0.001s gradually.
Too loud motor noise	<ul style="list-style-type: none"> ◆ Increase the setting of 01.15 (carrier frequency) by 1.0 kHz gradually. Note that increase in carrier frequency will result in an increase in the leakage current of the motor.
Insufficiency motor torque	<ul style="list-style-type: none"> ◆ Check whether torque upper limit is small. If yes, please Increase the setting of 03.10 (digital setting of torque upper limit in speed control mode) in the speed control mode ; Increase the torque reference in the torque control mode.
Obvious speed fluctuation	<ul style="list-style-type: none"> ◆ If motor speed fluctuation is large, increase the setting of 03.07 (SVC torque filter time) by 0.001s gradually.
Too loud motor noise	<ul style="list-style-type: none"> ◆ Increase the setting of 01.15 (carrier frequency) by 1.0 kHz gradually. Note that increase in carrier frequency will result in an increase in the leakage current of the motor.

Insufficient motor torque	<p>◆ Check whether torque upper limit is small. If yes, please: Increase the setting of 03.10 (digital setting of torque upper limit in speed control mode in the speed control mode).</p>
---------------------------	--

2) Drive in V/F Control (01.01=2 factory default)

It is applicable to application without an encoder for speed feedback. You need to set rated motor voltage and rated motor frequency correctly.

Error	Solution
Motor oscillation during running	1. Increase the setting of 04.11 (V/F oscillation suppression gain) by 10 gradually. The permissible maximum setting here is 100.
Over current during start	1. Decrease the setting of 04.01 (torque boost) by 0.5% gradually.
Too loud motor noise	1. Increase the setting of 01.15 (carrier frequency) by 1.0 kHz gradually. Note that increase in carrier frequency will result in an increase in the leakage current of the motor.
Very large current during running	1. Set rated motor voltage (02.02) and rated motor frequency (02.04) correctly. 2. Decrease the setting of 04.01 (torque boost) by 0.5% gradually.
Over voltage detected when heavy load is suddenly removed or during deceleration	1. Ensure that 04.23 (voltage limit selection) is set to 1 (enabled). Increase the setting of 04.24/04.25 (frequency gain/voltage gain for voltage limit) by 10 gradually. The permissible maximum setting here is 100. 2. Decrease the setting of 04.22 (voltage limit 770v) by 10 V gradually. The permissible minimum setting here is 700 V.
Over current detected when heavy load is suddenly added or during acceleration	1. Increase the setting of 04.20 (04.20 factory default set 20) by 10 gradually. The permissible maximum setting here is 100. 2. Decrease the setting of 04.18 (04.18 factory default is 150%) by 10% gradually. The permissible minimum setting here is 50%.

7.2 Fault Display

When a fault occurs during running, The operation panel displays the fault code such as shown in the following figure.

Fault	Displ	Fault reason	Error settlement
Over current during acceleration	E.oC1	Ground fault or short circuit exists in the output circuit.	<ul style="list-style-type: none"> ◆ Check whether short-circuit occurs on the motor, motor cable or contactor.
		Control mode is SVC but motor auto-tuning is not performed.	<ul style="list-style-type: none"> ◆ Set motor parameters according to motor nameplate and perform motor auto-tuning.
		Acceleration time is too short.	<ul style="list-style-type: none"> ◆ Increase acceleration time.
		The over current stall prevention parameters are set improperly.	<ul style="list-style-type: none"> ◆ Ensure that current limit is enabled (04.19 = 1). ◆ The setting of current limit level (04.18) is too large. Adjust it between 120% and 150%. ◆ The setting of current limit gain (04.20) is too small. Adjust it between 20 and 40.
		Customized torque boost or V/F curve is not appropriate.	<ul style="list-style-type: none"> ◆ Adjust the customized torque boost or V/F curve.
		The spinning motor is started.	<ul style="list-style-type: none"> ◆ Enable the catching a spinning motor function or start the motor
		The AC drive suffers external interference.	<ul style="list-style-type: none"> ◆ View historical fault records. If the current value is far from the over current level, find interference source. If external interference does not exist, it is the drive board or hall device problem.
Over current during deceleration	E.oC2	Ground fault or short circuit exists in the output circuit.	<ul style="list-style-type: none"> ◆ Check whether short-circuit occurs on the motor, motor cable or contactor.
		Control mode is SVC but motor auto-tuning is not performed.	<ul style="list-style-type: none"> ◆ Set the motor parameters according to the motor nameplate and perform motor auto-tuning.
		Acceleration time is too short.	<ul style="list-style-type: none"> ◆ Increase acceleration time.
		The over current stall prevention parameters are set	<ul style="list-style-type: none"> ◆ Ensure that current limit is enabled (04.19 = 1) ◆ The setting of current limit level

		improperly.	<p>(04.18) is too large. Adjust it between 120% and 150%.</p> <p>◆ The setting of the current limit gain (04.20) is too small. Adjust it between 20 and 40.</p>
		Braking unit and braking resistor are not installed.	◆ Install braking unit and braking resistor.
		The AC drive suffers external interference.	◆ View historical fault records. If the current value is far from the over current level, find interference source. If external interference does not exist, it is the drive board or hall device problem.
Over current at constant speed	E.oC3	Ground fault or short circuit exists in	◆ Check whether short-circuit occurs on the motor, motor cable or contactor.
		Control mode is SVC but motor auto-tuning is not performed	◆ Set motor parameters according to motor nameplate and perform motor auto-tuning.
		The over current stall prevention parameters are set improperly.	<p>◆ Ensure that current limit is enabled (04.19).</p> <p>◆ The setting of current limit level (04.18) is too large. Adjust it between 120% and 150%.</p> <p>◆ The setting of current limit gain (04.20) is too small. Adjust it between 20 and 40.</p>
		The AC drive power class is small.	◆ If output current exceeds rated motor current or rated output current of the AC drive during stable running, replace a drive of larger power class.
		The drive suffers external interference.	◆ View historical fault records. If the current value is far from the over current level, find interference source. If external interference does not exist, it is the drive board or hall device
Over voltage during acceleration	E.oU1	Input voltage is too high.	◆ Adjust input voltage to normal range.
		An external force drives motor during acceleration.	◆ Cancel the external force or install a braking resistor.

		The over voltage stall prevention parameters are set improperly.	<ul style="list-style-type: none"> ◆ Ensure that the voltage limit function is enabled (04.23). ◆ The setting of voltage limit (04.22) is too large. Adjust it between 700 V and 770 V. ◆ The setting of frequency gain for voltage limit (04.24) is too small. Adjust it between 30 and 50.
		Braking unit and braking resistor are not installed.	<ul style="list-style-type: none"> ◆ Install braking unit and braking resistor.
		Acceleration time is too short.	<ul style="list-style-type: none"> ◆ Increase acceleration time.
Over voltage during deceleration	E.oU2	The over voltage stall prevention parameters are set improperly.	<ul style="list-style-type: none"> ◆ Ensure that the voltage limit function is enabled (04.23). ◆ The setting of voltage limit (04.22) is too large. Adjust it between 700 V and 770 V. ◆ The setting of frequency gain for voltage limit (04.24) is too small. Adjust it between 30 and 50.
		An external force drives motor during deceleration.	<ul style="list-style-type: none"> ◆ Cancel the external force or install braking resistor.
		Deceleration time is too short.	<ul style="list-style-type: none"> ◆ Increase deceleration time.
		Braking unit and braking resistor are not installed.	<ul style="list-style-type: none"> ◆ Install braking unit and braking resistor.
Over voltage at constant speed	E.oU3	The over voltage stall prevention parameters are set improperly.	<ul style="list-style-type: none"> ◆ Ensure that the voltage limit function is enabled (04.23) ◆ The setting of voltage limit (04.22) is too large. Adjust it between 700 V and 770 V. ◆ The setting of frequency gain for voltage limit (04.24) is too small. Adjust it between 30 and 50. ◆ The setting of frequency rise threshold during voltage limit (04.26) is too small. Adjust it between 5 Hz and 20 Hz.
		An external force drives motor during running.	<ul style="list-style-type: none"> ◆ Cancel the external force or install a braking resistor

Pre-charge resistor fault	E.Br	Input voltage is not in arranged range	◆ Arrange voltage in a reasonable range
Under voltage	E.LU	Instantaneous power failure occurs	◆ Enable the power dip ride through function (10.59).
		The AC drive's input voltage is not within the permissible range.	◆ Adjust the voltage to normal range.
		The bus voltage is abnormal.	◆ Contact the agent or Pentax Inverter.
		The rectifier bridge, the buffer resistor, the drive board or the control board are abnormal.	◆ Contact the agent or Pentax Inverter.
AC drive overload	E.oL1	Load is too heavy or locked-rotor occurs on motor.	◆ Reduce load or check motor and mechanical conditions.
		The AC drive power class is small.	◆ Replace a drive of larger power class.
Motor overload	E.oL2	10.01 (Motor overload protection gain) is set improperly.	◆ Set 10.01 correctly.
		Load is too heavy or locked-rotor occurs on motor.	◆ Reduce load or check motor and mechanical conditions.
Output phase loss	E.PHo	Motor winding is damaged.	◆ Check resistance between motor wires. ◆ Replace motor is winding is damaged.
		The cable connecting the AC drive and the motor is abnormal.	◆ Check for wiring errors and ensure the output cable is connected properly Correct wiring.
		The AC drive's three-phase outputs are unbalanced when the motor is running.	◆ Check whether the motor three-phase winding is normal.
		The drive board or the IGBT is abnormal.	◆ Contact the agent or Pentax Inverter.

Overheat	E.oH1	The ambient temperature is too high.	◆ Lower the ambient temperature.
		The ventilation is clogged.	◆ Clean the ventilation.
		The fan is damaged.	◆ Replace the cooling fan.
		Thermally sensitive resistor of IGBT is damaged.	◆ Replace the damaged thermally sensitive resistor.
		The AC Drive Inverter module is damaged.	◆ Replace the AC Drive Inverter module.
Out project fault	E.SET	External fault signal is input via S.	◆ Confirm that the mechanical condition allows restart (09.18) and reset the operation.
Communication fault	E.CE	Host computer is in abnormal state.	◆ Check the cable of host computer.
		Communication cable is abnormal.	◆ Check the communication cables.
		The serial port communication protocol (01.28) of extension communication card is set improperly.	◆ Set extension communication card correctly.
		Communication parameters in group Pd are set improperly.	◆ Set communication parameters in group Pd properly.
		After all the preceding checking are done but the fault still exists, restore the default settings.	
Contactor fault	E.CoN	Drive board and power supply are abnormal.	◆ Replace drive board or power supply board.
		Contactor is abnormal.	◆ Replace contactor.
		The lightning protection board is abnormal.	◆ Replace the lightning protection board.
Current detection failure	E.oCC	The hall is abnormal.	◆ Replace the hall .
		The drive board is abnormal.	◆ Replace the drive board.
Motor self learning faulty	E.TE	Motor parameters are not set according to nameplate.	◆ Set motor parameters correctly according to nameplate.

		Motor auto-tuning times out.	◆ Check the cable connecting AC drive and motor.
		The encoder is abnormal.	◆ Check whether 02.27 (encoder pulses per revolution) is set correctly. Check whether signal lines of encoder are connected correctly and securely.
EEPROM read-write fault	E.EEP	The EEPROM chip is damaged.	◆ Replace the main control board.
Short circuit to ground	E.STG	Motor is short circuited to the ground.	◆ Replace cable or motor.
Accumulative running time reached	E.TIo	Accumulative running time reaches the setting value.	◆ Clear the record through parameter initialization.
User-defined fault 1	E.USE 1	User-defined fault 1 is input via S.	◆ Reset the operation.
User-defined fault 2	E.USE 2	User-defined fault 2 is input via virtual S	◆ Reset the operation.
Accumulative power reach error	E.PUT O	Accumulative power-on time reached	◆ Use the parameter initialization function to clear the record information
Load loss	E.LO AD	Working current <10.64	◆ Check whether the load is off or 10.64, 10.65 parameter set Whether to meet the actual operating conditions
PID feedback lost during running	E.PId	PID feedback <11.26 set value	◆ Check PID feedback or set 11.26 properly.
Pulse-by-pulse current limit fault	E.CB C	Load is too heavy or locked-rotor occurs on motor.	◆ Reduce load or check motor and mechanical conditions
		The AC drive power class is small.	◆ Replace a drive of larger power class.
Motor switchover fault during running	E.SrU N	Motor switchover via terminal during drive running of the AC drive.	◆ Perform motor switchover after the AC drive stops.
Speed error	E.SSD	Encoder parameters are set improperly.	◆ Set encoder parameters properly.

		Motor auto-tuning is not performed.	◆ Perform motor auto-tuning.
		10.69 (detection level of speed error) and 10.70 (detection time of speed error) are set incorrectly.	◆ Set data correctly based on actual condition
Motor over speed	E.oS	Encoder parameters are set improperly.	◆ Set encoder parameters properly.
		Motor auto-tuning is not performed.	◆ Perform motor auto-tuning.
		10.67 (Over speed detection level) and 10.68 (Over speed detection time) are set incorrectly.	◆ Set data correctly based on the actual situation.
Motor over temperature fault	E.oH2	1. The temperature sensor wiring is loose 2. Motor temperature is too high	◆ Detect temperature sensor wiring and troubleshoot ◆ Reduce the carrier frequency or take other cooling measures to dissipate heat to the motor
wrong initial position	E.INI T	The motor parameters and the actual deviation are too large	◆ Re-confirm whether the motor parameters are correct, focusing on whether the rated current is set too small
High water pressure failure	A-HP	The feedback pressure value is greater than the high pressure alarm value setting (15.04)	◆ Check the feedback value of the pressure sensor
Low water pressure failure	A-LP	The feedback pressure value is less than the low pressure alarm value setting (15.05)	◆ Check the feedback value of the pressure sensor

Chapter 8 RS485 Communication Protocol

8.1 Modbus communication protocol

8.1.1 Introduction

DSI-100 series inverters provide RS485 communication interface, and use the international standard MODBUS communication protocol for master-slave communication. Users can realize centralized control through PC/PLC, control host computer, etc. (setting inverter control commands, operating frequency, relevant function code parameters, monitoring inverter working status and fault information, etc.) to meet specific application requirements.

8.1.2 Details

1. Contents of the agreement

The serial communication protocol defines the content and format of information transmitted in serial communication. It includes: host polling (or broadcast) format; host encoding method, including: function code required for action, transmission data and error checking, etc. The response of the slave also adopts the same structure, including: action confirmation, return data and error checking, etc. If the slave has an error in receiving the information, or cannot complete the action required by the master, it will organize a fault message as a response and feed it back to the master.

2. Application method

The inverter is connected to the "single master and multiple slave" PC/PLC control network with RDI485 bus.

8.1.3 The bus structure

(1) Interface mode: RS485

(2) Transmission method:

Asynchronous serial, half-duplex transmission mode. At the same time, only one of the master and slave can send data and the other can only receive data. In the process of serial asynchronous communication, data is sent frame by frame in the form of messages.

(3) Topological structure:

Single master multi-slave system. The setting range of the slave address is 1 to 247, and 0 is the broadcast communication address. Slave addresses in the network must be unique. As shown below:

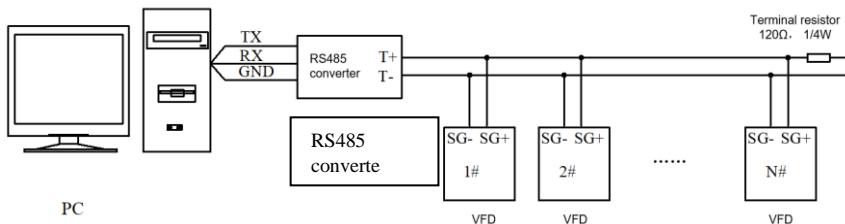

8.1.4 Description of the agreement

DSI-100 series inverter communication protocol is an asynchronous serial master-slave MODBUS communication protocol. Only one device (host) in the network can establish the protocol (called "query/command"). Other devices (slaves) can only respond to the "query/command" of the host by providing data, or make corresponding actions according to the "query/command" of the host. The host here refers to a personal computer (PC), industrial control equipment or a programmable logic controller (PLC), etc., and the slave refers to a 300 inverter. The master can not only communicate with a certain slave, but also publish broadcast information to all the lower slaves. For the "inquiry/command" of the host that is accessed individually, the slave must return a message (called a response). For the broadcast information sent by the host, the slave does not need to respond to the host.

8.1.5 Communication data structure

The MODBUS protocol communication data format of DSI-100 series inverter is divided into RTU (remote terminal unit mode).

(1) In RTU mode, the format of each byte is as follows:

Using RTU mode, message transmission starts with a pause interval of at least 3.5 character times. This is the easiest to implement with a variety of character times at the network baud rate (as shown in T1-T2-T3-T4 in the figure below). The first field of the transfer is the device address. The transfer characters that can be used are 0...9,A...F in hexadecimal. The network device continuously detects the network bus,

including the pause interval. When the first field (address field) is received, each device decodes it to determine whether it is destined for its own. After the last transmitted character, a pause of at least 3.5 character times marks the end of the message. A new message can start after this pause. The entire message frame must be transmitted as a continuous stream. If there is a pause of more than 1.5 character times before the frame is complete, the receiving device will flush the incomplete message and assume that the next byte is the address field of a new message. Likewise, if a new message follows the previous message in less than 3.5 characters, the receiving device will consider it a continuation of the previous message. This will cause an error because the value in the final CRC field cannot be correct.

RTU frame format:

Frame header START	T1-T2-T3-T4 (3.5 bytes transfer time)
Slave address field ADDR	Communication address: 0 ~ 247 (decimal) (0 is the broadcast address)
Function code field CMD	03H: read slave parameters; 06H: write slave parameters
DATA field DATA (N-1) ... DATA (0)	2*N bytes of data, this part is the main content of communication and the core of data exchange in communication.
CRC CHK Low bits	Detection value: CRC check value (16BIT)
CRC CHK High bits	
Frame end END	T1-T2-T3-T4 (3.5 bytes transfer time)

CMD (command command) and DATA (data word description) command code: 03H, read N words (Word) (up to 16 words can be read) For example: the start address of the inverter whose slave address is 01 is 0107 consecutive Read 2 consecutive values host command information RTU host command information

START	T1-T2-T3-T4
ADDR	01H
CMD	03H
Start address high bit	01H
Start address low bit	07H
Number of data high bit	00H
Number of data low bit	02H
CRC CHK low bit	Its CRC CHK value to be calculated
CRC CHK high bit	
END	T1-T2-T3-T4

RTU slave response information

START	T1-T2-T3-T4
ADDR	01H
CMD	03H
Number of bytes	04H
DATA address 0007H high bit	13H
DATA address 0007H low bit	88H
DATA address 0008H high bit	13H
DATA address 0008H low bit	88H

CRC CHK low bit	Its CRC CHK value to be calculated
CRC CHK high bit	
END	T1-T2-T3-T4

Check method - CRC check method:

CRC (Cyclical Redundancy Check)

Using the RTU frame format, the message includes an error detection field based on the CRC method. The CRC field detects the content of the entire message. The CRC field is two bytes containing a 16-bit binary value. It is calculated by the transmitting device and added to the message. The receiving device recalculates the CRC of the received message and compares it with the value in the received CRC field. If the two CRC values are not equal, it means that there is an error in the transmission.

The CRC is stored in 0xFFFF first, and then a process is called to process the consecutive 8-bit bytes in the message with the value in the current register. Only the 8Bit data in each character is valid for CRC, and the start and stop bits and parity bits are invalid. In the process of CRC generation, each 8-bit character is XORed with the contents of the register independently, and the result is moved to the direction of the least significant bit, and the most significant bit is filled with 0. The LSB is extracted and detected. If the LSB is 1, the register is individually ORed with the preset value. If the LSB is 0, it is not performed. The whole process is repeated 8 times. After the last bit (8th bit) is completed, the next 8-bit byte is XORed with the current value of the register independently. The value in the final register is the CRC value after all bytes in the message are executed.

When the CRC is added to the message, the low byte is added first, then the high byte. The CRC simple function is as follows:

```
unsigned int crc_chk_value (unsigned char *data_value, unsigned char length)
```

```
{
  unsigned int crc_value=0xFFFF;
  int i;
  while(length-->0)
  {
    crc_value^=*data_value++;
    for(i=0;i<8;i++)
    {
      if(crc_value&0x0001)
      {
        crc_value=(crc_value>>1)
        ^0xa001;
      }
      else
      {
        crc_value=crc_value>>1;
      }
    }
  }
  return(crc_value);
}
```

8.2 Address Definition of Communication Parameters

This part is the content of communication, which is used to control the operation of the inverter, the status of the inverter and the setting of related parameters.

Read and write function code parameters (some function codes cannot be changed and are only used by manufacturers):

Function code parameter address marking rules:

The rules are represented by the function code group number and label as the parameter address:

High byte: 70 (00) 、 F0~FF (01-16) 、 A0~AC (18-30)

Lower byte: 00~FF

Such as: 02.10, the address is expressed as F10A (hexadecimal);

18.01, the address is represented as A001 (hexadecimal);

Note:

Group 00: Only parameters can be read, and parameters cannot be changed;

Group 16: Neither can read parameters nor change parameters; some parameters cannot be changed when the inverter is running; some parameters cannot be changed no matter what state the inverter is in; when changing the function code parameters, pay attention to the parameters The range, units, and related descriptions.

In addition, because the EEPROM is frequently stored, the service life of the EEPROM will be reduced. Therefore, some function codes do not need to be stored in the communication mode, but only need to change the value in the RAM. To realize this function, just change the high-order **F** of the function code address (01~16) to **0**, and then change the high-order **A** of the function code address (18~30) to **4**.

The following table:

Function code group number	Function code communication access address (EEPROM)	Communication modification function code address (RAM)
00	0x7000-0x70FF	
01~16	0xF000-0xFFFF	0x0000-0x0FFF
18~30	0xA000-0xACFF	0x4000-0x4CFF

The corresponding function code addresses are shown as follows:

High byte: 00~0F (01~16), 40~4F (18~30)

Lower byte: 00~FF

For example, the function code 02.10 is not stored in the EEPROM, and the address is expressed as 010AH; this address indicates that it can only be written to RAM, but cannot be read, and it is an invalid address when reading.

Stop/Run Parameters Section:

Parameter address	Parameter Description
1000H	* Communication setup value(-10000~10000)(Decimal)
1001H	Running frequency
1002H	Bus voltage
1003H	Output voltage
1004H	Output current
1005H	Output power
1006H	Output torque
1007H	Running speed
1008H	DI input status
1009H	DO output status
100AH	AI1 voltage
100BH	AI2 voltage
100CH	AI3 voltage
100DH	Counting value input
100EH	Length value input
100FH	Load speed
1010H	PID setup
1011H	PID feedback
1012H	PLC process
1013H	PULSE input pulse frequency, unit 0.01kHz

1014H	Feedback speed, unit 0.1Hz
1015H	Rest running time
1016H	AI1 voltage before correction
1017H	AI2 voltage before correction
1018H	AI3 voltage before correction
1019H	Line speed
101AH	Current power on time
101BH	Current running time
101CH	PULSE input pulse frequency, unit 1Hz
101DH	Communication setup value
101EH	Actual feedback speed
101FH	Main frequency X display
1020H	Auxiliary frequency Y display

Caution:

The communication setup value is percentage of the relative value, 10000 corresponds to 100.00% , -10000 corresponds to -100.00%.For data of dimensional frequency,the percentage value is the percentage of the maximum frequency.

Control command input to the inverter (write-only)

Command word address	Command function
2000	0001: Forward operation
	0002: Reverse operation
	0003: Forward jog
	0004: Reverse jog
	0005: Free stop
	0006: Deceleration stop
	0007: Fault reset

Read inverter status: (read-only)

Status word address	Status word function
3000	0001: Forward operation
	0002: Reverse operation
	0003: Stop

Parameters lock password check: (if the return is the 8888H, it indicates the password checksum pass)

Password address	Contents of input password
1F00	*****

The address for communication parameter initialization is 1F01H, and its data content is defined as follows:

Parameter initialization communication address	Command content

1F01H	1: Restore factory parameters
	2:Clear record information
	4:Restoring user backup parameters
	5:Backup user current parameters

Digital output terminal control: (write-only)

Command address	Command content
2001	BIT0: DO1 Output control BIT1: DO2 Output control BIT2 RELAY1 Output control BIT3: RELAY2 Output control BIT4: Y1R Output control BIT5 :VDO1 BIT6 :VDO2 BIT7 :VDO3 BIT8 :VDO4 BIT9 :VDO5

Analog output AO1 control: (write-only)

Command address	Command content
2002	0~7FFF indicates 0%~100%

Analog output AO2control: (write-only)

Command address	Command content
2003	0~7FFF indicates 0%~100%

(PULSE) output control : (write-only)

Command address	Command content
2004	0~7FFF indicates 0%~100%

Inverter fault description:

fault address	fault code	fault information
8000H		0000:No fault
		0001:Reserved
	E.oC1	0002:Speed-up over current (oC1)
	E.oC2	0003:Speed-down over current (oC2)
	E.oC3	0004:Constant speed over current (oC3)
	E.oU1	0005:Speed-up over voltage (oU1)
	E.oU2	0006:Speed-down over voltage (oU2)
	E.oU3	0007:Constant speed over voltage (oU3)
	E.Br	0008:Buffer resistance overload fault
	E.LU	0009:Under-voltage fault (LU)
	E.oL2	000A:Inverter overload (oL2)
	E.Ol1	000B:Motor overload (oL1)
	E.PHI	000C:Input phase lost (PHI)

E.PHo	000D:Output phase lost (PHo)
E.oH1	000E:IGBT Module overheating (oH1)
E.SET	000F:External fault (EF)
E.CE	0010:Communication fault (CE)
E.CoN	0011:DC Contactor fault
E.oCC	0012:Current detection fault (oCC)
E.TE	0013:Motor tuning fault (TE)
E.Enco	0014:Encoder/PG card fault
E.EEP	0015:EEPROM faulty (EEP)
E.INT	0016:Inverter hardware fault
E.STG	0017:Motor earthing short-circuit fault
E.BL	0018:Reserved
E.oH2	0019:Reserved
E.TIo	001A:Running time arrive fault
E.USE1	001B>User defined fault 1
E.USE2	001C>User defined fault 2
E.PUTo	001D:Power on time arrive fault
E.LOAD	001E:Load off
E.PId	001F:PID feedback lost during operation (PIDE)
E.CBC	0028:Fast current limit timeout fault
E.SrUN	0029:Motor shifting fault during operation
E.SDD	002A:Excessive speed deviation
E.oS	002B:Motor over speed
E.OH2	002D:Motor over-temperature
E.INIT	005A:Encoder line number setup fault
E.FDB	005B:Encoder not connected
E.INIT	005C:Initial position error
E.ESD	005D:Speed feedback fault

Communication fault information describing data (fault code):

Communication fault address	Fault function description
8001	0000: No fault 0001: Password error 0002: Command code error 0003: CRC check error 0004: Invalid address 0005: Invalid parameter 0006: Parameter change invalid 0007: The system is locked 0008: Operating EEPROM

